

TR62IBL2

Cooker size	60x60 cm
N. of cavities with energy label	2
Cavity heat source	Electric
Hob type	Induction
Type of main oven	Thermo-ventilated
Type of second oven	Static
EAN code	8017709309541
Energy efficiency class	A
Energy efficiency class, second cavity	A



Aesthetics

Aesthetics	Victoria	Display	electronic 5 buttons
Colour	Black	Colour of buttons	Black
Finishing	Gloss Black	No. of controls	6
Design	Victoria	Serigraphy colour	Silver
Door	With frame	Handle	Smeg Victoria
Upstand	Yes	Handle Colour	Brushed stainless steel
Hob colour	Black enamel	Glass type	Black
Command panel finish	Enamelled metal	Plinth	Anthracite
Control knobs	Smeg Victoria	Logo	assembled 50's
Controls colour	Stainless steel	Logo position	Upstand

Programs / Functions

No. of cooking functions 4

Traditional cooking functions



Static



Small grill



Large grill



Base

Hob technical features



Total no. of cook zones 4

Front left - Induction - single - 2.30 kW - Booster 3.00 kW - - Ø 21.0 cm

Rear left - Induction - single - 1.20 kW - Booster 1.40 kW - - Ø 16.0 cm

Rear right - Induction - giant - 2.30 kW - Booster 3.00 kW - - Ø 21.0 cm

Front right - Induction - single - 1.20 kW - Booster 1.40 kW - - Ø 16.0 cm

No. of cooking zones with Booster	4	Minimum pan diameter indication	Yes
Automatic switch off when overheat	Yes	Selected zone indicator	Yes
Automatic pan detection	Yes	Residual heat indicator	Yes

Main Oven Technical Features



No. of lights	1	Removable door	Yes
Fan number	1	Full glass inner door	Yes
Net volume of the cavity	61 litres	Removable inner door	Yes
Gross volume, 1st cavity	70 l	Total no. of door glasses	3
Cavity material	Easy clean enamel	No. of thermo-reflective door glasses	1
Shelf positions	4	Safety Thermostat	Yes
Type of shelves	Metal racks	Cooling system	Tangential
Light type	Halogen	Usable cavity space dimensions (HxWxD)	316x460x412 mm
Light power	40 W	Temperature control	Electro-mechanical
Cooking time setting	Start and Stop	Circular heating element - Power	2700 W
Door opening	Flap down		

Options Main Oven

Timer	Yes	Minimum Temperature	50 °C
End of cooking acoustic alarm	Yes	Maximum temperature	245 °C

Second Oven Technical Features



Net volume of the second cavity	35 litres	No. total door glasses	3
Gross volume, 2nd cavity	41 l	No. thermo-reflective door glasses	1
Cavity material	Easy clean enamel	Safety Thermostat	Yes
Shelf positions	2	Cooling system	Tangential
Type of shelves	Metal racks	Usable cavity space dimensions (HxWxD)	169x440x443 mm
No. of lights	1	Temperature control	Electro-mechanical
Light type	Halogen	Lower heating element - power	1200 W
Light power	40 W	Upper heating element - Power	1000 W
Door opening	Flap down		
Removable door	Yes		

Full glass inner door	Yes	Grill element - power	1700 W
Removable inner door	Yes	Large grill - Power	2700 W
		Grill type	Electric
		Tilting grill	Yes

Options Auxiliary Oven

Minimum Temperature	50 °C	Maximum temperature	245 °C
---------------------	-------	---------------------	--------

Accessories included for Main Oven & Hob



Rack with back and side stop	2	Grill mesh	1
40mm deep tray	1	Telescopic Guide rails, total Extraction	1

Accessories included for Secondary Oven

Rack with back and side stop	1	Grill mesh	1
40mm deep tray	1		

Electrical Connection

Max Power Draw	12700 W	Type of electric cable installed	Yes, Single phase
Current	38 A	Type of electric cable	Yes, Double and Three Phase
Voltage	220-240 V	Frequency	50/60 Hz
Voltage 2 (V)	380-415 V	Terminal block	5 poles

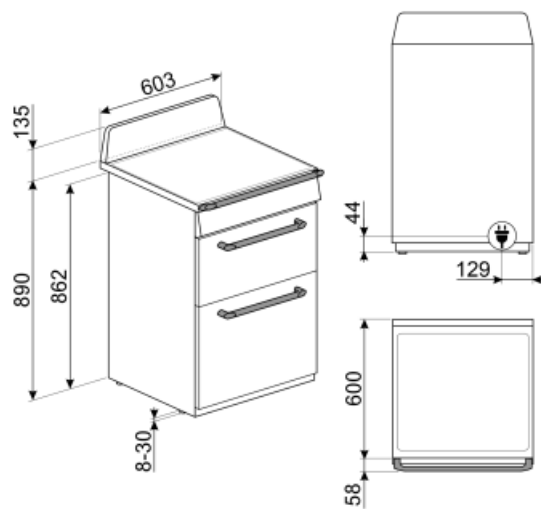

Not included accessories



KIT1TR6N

Splashback, 60x75 cm suitable for 60 cm Victoria cookers, black



SFLK1

Child lock



PRTX

Refractory pizza stone with handles. D=35cm Not suitable for microwave ovens. Suitable for gas ovens, to be put on the griddle.

GRILLPLATE



Universal griddle for induction, gas, ceramic and electric hobs. Non-stick surface ideal for cooking meat, cheese and vegetables. Dimensions: 410 x 240 mm.



BN620-1

Enamelled tray, 20mm deep

BBQ

Double sided plate BBQ. Suitable for recreating succulent and crispy dishes in the oven with the typical taste of grilled cooking. The ribbed side is particularly suitable for meats and cheeses. The smooth side for fish, seafood and vegetables.



PALPZ

Pizza shovel with fold away handle width: 315mm length : 325mm



AIRFRY

Air fryer rack AIRFRY . Ideal for recreating traditional frying in the oven, but with fewer calories and less fat. It allows you to cook quickly and simply dishes such as French fries, fried vegetables and fish, ensuring perfect browning and crispiness.



GTP

Partially extractable telescopic guides (1 level) Extraction: 300 mm Material: Stainless steel AISI 430 polished



BNP608T

Teflon-coated tray, 8mm depth, to be placed on the grid



KITH60

Height extension kit (950 mm), suitable for TR60 cookers



SCRP

Induction and ceramic hobs and teppanyaki scraper



TPKPLATE

Universal plate for induction, gas, ceramic and electric hobs. Non-stick surface ideal for cooking fish, eggs and vegetables. Dimensions: 410 X 240 mm.



GTT

Totally extractable telescopic guides (1 level) Extraction: 433 mm Material: Stainless steel AISI 430 polished



BN640



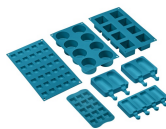





















Enamelled tray, 40mm deep



SMOLD

Set of 7 silicone moulds for ice creams, ice lollies, pralines, ice cubes or to portion food. Usable from -60°C to +230°C

Symbols glossary

 <p>P Power booster: option allows the zone to work at full power when very intense cooking is necessary.</p>	 <p>Child lock: some models are fitted with a device to lock the programme/cycle so it cannot be accidentally changed.</p>
 <p>A A: Product drying performance, measured from A+++ to D / G depending on the product family</p>	 <p>Air cooling system: to ensure a safe surface temperatures.</p>
 <p>3 Triple glazed doors: Number of glazed doors.</p>	 <p>ECO-logic: option allows you to restrict the power limit of the appliance real energy saving.</p>
 <p>Enamel interior: The enamel interior of all Smeg ovens have a special antacid lining which helps keep the interior clean by reducing the amount of cooking grease adhering to it.</p>	 <p>Upper and lower element only: a traditional cooking method best suited for single items located in the centre of the oven. the top pf the oven will always be hottest. Ideal for roast, fruit cakes, bread etc.</p>
 <p>Lower heating element only: This function is ideal for foods that require extra base temperature without browning, e.g. pastry dishes, pizza. Also suitable for slow cooking of stews and casseroles.</p>	 <p>Grill element: Using of grill gives excellent results when cooking meat of medium and small portions, especially when combined with a rotisserie (where possible). Also ideal for cooking sausages and bacon.</p>
 <p>Half grill: For rapid cooking and browning of foods. Best results can be obtained by using the top shelf for small items, the lower shelves for larger ones, such as chops or sausages. For half grill heat is generated only at the centre of the element, so is ideal for smaller quantities.</p>	 <p>Giant zone: The giant zone offers extra space and flexibility.</p>
 <p>STOP °C Overheat protection: The safety system that automatically turns off the hob in case of overheating of the control unit.</p>	 <p>Induction: The work of these hobs is based on the principle of electromagnetic induction. The heat is generated directly in the bottom of the pan during its contact with the hob.</p>
 <p>All glass inner door: All glass inner door, a single flat surface which is simple to keep clean.</p>	 <p>The inner door glass: can be removed with a few quick movements for cleaning.</p>
 <p>Side lights: Two opposing side lights increase visibility inside the oven.</p>	 <p>H Indication of residual heat: After the glass ceramic hob is switched off the residual heat indicator shows which of the heating zones still remains hot. When the temperature drops below 60 ° C, the indicator goes out.</p>
 <p>2 The oven cavity has 2 different cooking levels.</p>	 <p>4 The oven cavity has 4 different cooking levels.</p>
 <p>Telescopic rails: allow you to pull out the dish and check it without having to remove it from the oven entirely.</p>	 <p>Electronic control: Allows you to maintain temperature inside the oven with the precision 2-3 ° C. This enables to cook meals that are very sensitive to temperature changes, such as cakes, souffles, puddings.</p>
 <p>Tilting grill: the tilting grill can be easily unhooked to move the heating element and clean the roof of the appliance in one simple step.</p>	 <p>35 lt The capacity indicates the amount of usable space in the oven cavity in litres.</p>



The capacity indicates the amount of usable space in the oven cavity in litres.