

# SO4101M0B3

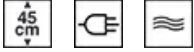

Category	45 cm
Product Family	Oven
Power supply	Electric
Heat source	ELECTRICITY
Cooking method	Microwave with grill
Galileo platform	Micro + grill
EAN code	8017709341633



## Aesthetics

Aesthetic	Linea	Door	Full glass
Colour	Black	Handle	Linea minimal
Design	Flat	Handle Colour	Black
Material	Glass	Logo	Silk screen
Glass Type	Clear	Control knobs	Linea
Serigraphy colour	Grey	Controls colour	Black
Serigraphy type	Symbols		

## Controls



Display name	CompactScreen	Control setting	Knobs
Display technology	LCD	No. of controls	2

## Programme / Functions

No. of cooking functions 4  
 Traditional cooking functions



Microwave functions

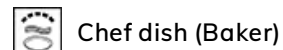

## Other functions

 Defrost by time

## Options



<b>Time-setting options</b>	Delay start and automatic end cooking	<b>Controls Lock / Child Safety</b>	Yes
<b>Minute minder</b>	Yes	<b>Other options</b>	Keep warm
<b>Timer</b>	1	<b>Showroom demo option</b>	Yes

## Technical Features



<b>Minimum Temperature</b>	50 °C	<b>Door</b>	Temperate door
<b>Maximum temperature</b>	250 °C	<b>Total no. of door glasses</b>	3
<b>No. of shelves</b>	2	<b>Microwave stops when door is opened</b>	Yes
<b>No. of lights</b>	1	<b>Chimney</b>	Fixed
<b>Light type</b>	Halogen	<b>Cooling system</b>	Tangential
<b>Light Power</b>	40 W	<b>Cooling duct</b>	Single
<b>Light when door is opened</b>	Yes	<b>Usable cavity space dimensions (HxWxD)</b>	240x462x401 mm
<b>Grill element - power</b>	1500 W	<b>Temperature control</b>	Electronic
<b>Heating suspended when door is opened</b>	Yes	<b>Cavity material</b>	Ever clean Enamel
<b>Door opening type</b>	Standard opening	<b>Microwave screen protection</b>	Yes

## Performance / Energy Label



<b>Net volume of the cavity</b>	40 l	<b>Microwave effective power</b>	800 W
<b>Number of cavities</b>	1		

## Accessories Included







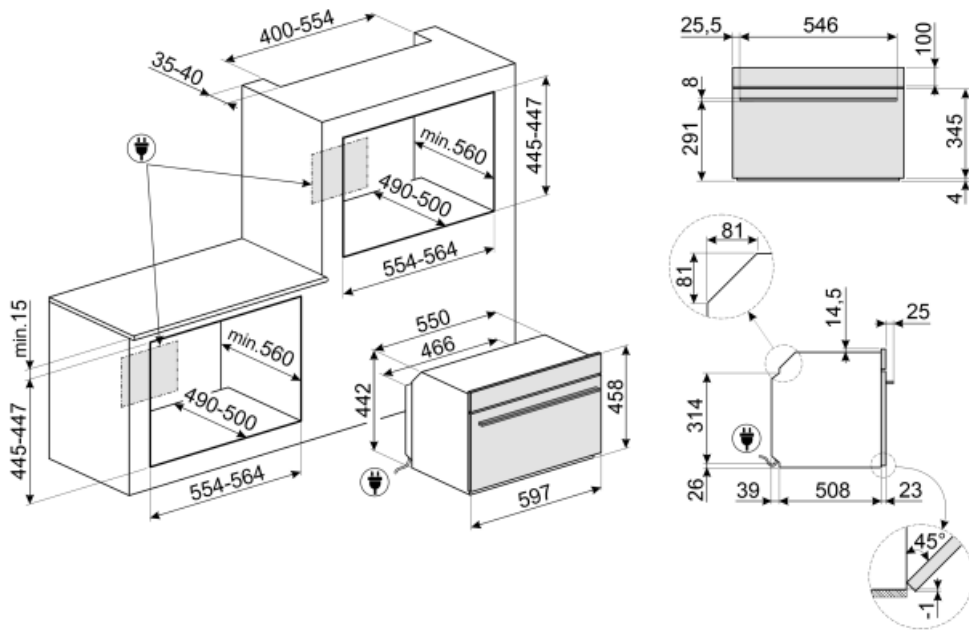











**Rack with back stop (concave)** 1

## Electrical Connection

<b>Voltage</b>	220-240 V	<b>Frequency (Hz)</b>	50 Hz
<b>Current</b>	13 A	<b>Power supply cable length</b>	150 cm
<b>Nominal power</b>	3000 W		



## Symbols glossary (TT)

 <p>Child lock: some models are fitted with a device to lock the programme/cycle so it cannot be accidentally changed.</p>	 <p>Microwave energy shortens cooking times dramatically and produces energy savings.</p>
 <p>Air cooling system: to ensure a safe surface temperatures.</p>	 <p>Defrost by time: Manual defrost function. At the end of the set duration, the function stops.</p>
 <p>With a simple and intuitive interface, the COMPACTscreen provides a pleasant user experience, thanks to the interaction with the knobs.</p>	 <p>Triple glazed doors: Number of glazed doors.</p>
 <p>Electric</p>	 <p>Ever Clean Enamel: Ever Clean enamel is applied electrostatically, corner to corner and edge to edge to prevent cracking or cracks over time. It is a particular pyrolytic enamel, resistant to acids which, in addition to being pleasantly bright, promotes greater cleaning of the oven walls, thanks to its lower porosity. It is baked at over 850 ° C and slowly polymerized at a scientifically determined rate to ensure uniform depth and strength Ever Clean enamel creates an impeccable finish both on the inside of the oven and on the trays, making the surfaces of the oven incredibly easy to maintain over time as it reduces the adhesion of fat during cooking</p>
 <p>Crisper: The simultaneous operation of the microwave, grill and crisper plate (once pre-heated) allows the food to go crispy and golden, ideal for cooking Pizza etc</p>	 <p>Grill: Very intense heat coming only from above from a double heating element. The fan is not active. Provides excellent grilling and gratinating results. Used at the end of cooking, it gives a uniform browning to dishes.</p>
 <p>Microwave: Penetrating straight into the food, microwaves cook very quickly and with considerable energy savings. Suitable for cooking without fat, they are also able to thaw and heat food without altering its original appearance and aroma. The microwave function can also be combined with conventional functions with all the resulting advantages. Ideal for all types of food.</p>	 <p>Microwave + grill element: The use of the grill results in a perfect browning of the surface of the food. The action of microwaves allows instead of cooking in a short time the internal part of the food.</p>
 <p>Compact appliances with a height of 45 cm - perfect solution to meet the functional requirements of kitchen sets of small height. Available in several types and in different styles.</p>	 <p>KEEP_WARM_72dpi</p>
 <p>Side lights: Two opposing side lights increase visibility inside the oven.</p>	 <p>The oven cavity has 2 different cooking levels.</p>
 <p>Electronic control: Allows you to maintain temperature inside the oven with the precision 2-3 ° C. This enables to cook meals that are very sensitive to temperature changes, such as cakes, souffles, puddings.</p>	 <p>Tilting grill: the tilting grill can be easily unhooked to move the heating element and clean the roof of the appliance in one simple step.</p>



---

The capacity indicates the amount of usable space in the oven cavity in litres.