

## SBS63XDE



Product Family	Refrigerator
Installation	Free standing
Category	Side-by-side
Reference width	Higher than 80
Reference height	160 - 200
Sistema Total No - Frost	Total
Cooling type	Fan assisted refrigerator, no-frost freezer
Defrost	Automatic
Hinge type	Standard
EAN code	8017709337636



## Aesthetics



Aesthetic	Universale	Side material	Steel
Colour	Inox-look	Side colour	Silver
Design	Flat	Logo	Applied
Material	Steel Effect	Drawers profile color	Silver
Handle	External	Color of glass shelf profile	Silver
Handle type	Fixed	Display	LED
Handle colour	Stainless steel	Display position	Esterno (su porta)
Logo colour	Chrome		

## Refrigerator compartment features



No. of adjustable shelves	3	Type of crisper/vegetable drawers cover	Glass
Number of fruit and vegetables drawers	2	Life Plus zone-0°C	Yes
Type of adjustable shelves	Glass	Internal light in fridge	Yes
Type of crisper/vegetable drawers cover	Standard	Type of internal light (fridge)	LED
Crisper Cover	Yes		

## Refrigerator Inner Door

Number of adjustable door shelves	4	No. of bottle shelves	1
-----------------------------------	---	-----------------------	---

## Other Refrigerator features



Accessories	Egg tray	Fan Ionizer	Yes
Natural Plus Blu Light	Yes	Antibacterial odour filter	Yes
MultiFlow	Yes		

## Freezer compartment features

Number of drawers	2	Type of internal light (freezer)	LED
No. of shelves	4	Type of shelves	Glass
Internal light in freezer	Yes		

## Freezer Inner Door

No. of adjustable door shelves	4
--------------------------------	---

## Other Freezer features



Manual ice maker	Yes	Fast freezing compartment	Yes
Ice maker	Manual		

## Other technical features

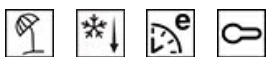

Functions display	Holiday, Fast freezing, Fast cooling, ECO, Control lock, Temperature alarm
Fast freezing button	Yes
Door open alarm	Yes
Temperature Alarm	Yes
Type of temperature control	Electronic
No. of compressors	1
Refrigerant gas type	R600a
Foam agent	Cyclopentane

## Performance / Energy Label NEW 2019









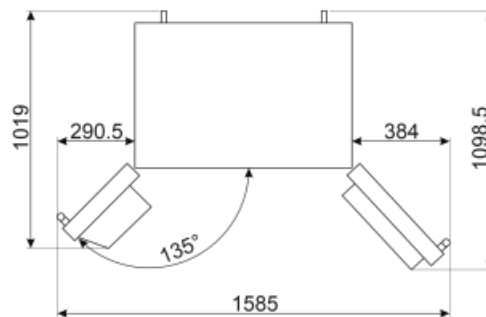
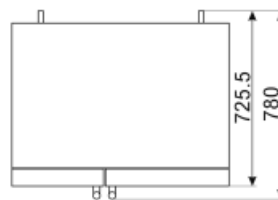
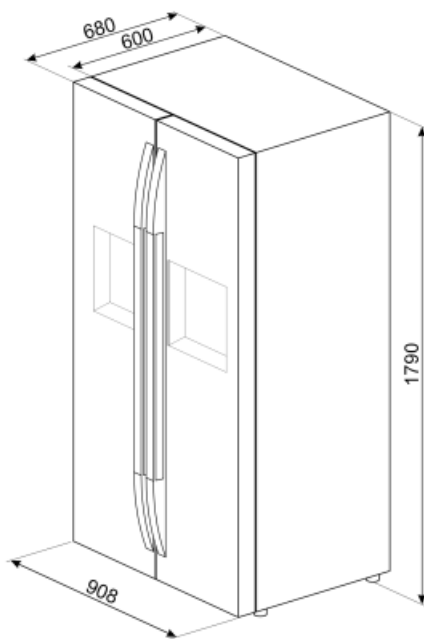







<b>Annual energy consumption</b>	327 kWh/a	<b>Airborne acoustical noise emissions</b>	38 dB(A) re 1pW
<b>Energy efficiency class</b>	E	<b>Temperature Rise Time</b>	9 h
<b>Airborne acoustical noise emission class</b>	C	<b>4 star - Freezing capacity</b>	13.0 Kg/24h
<b>Total net volume</b>	580 l	<b>Climate class</b>	SN, N, ST, T
<b>Sum of the volumes of the frozen compartment(s)</b>	212 l	<b>EEl</b>	99 %
<b>Sum of the volumes of the chill compartment(s) and the unfrozen compartment(s)</b>	368 l		

## Electrical Connection

<b>Plug</b>	(F;E) Schuko	<b>Voltage (V)</b>	220-240 V
<b>Electrical connection rating</b>	150 W	<b>Frequency (Hz)</b>	50 Hz
<b>Current</b>	0,85 A	<b>Power supply cable length</b>	215 cm



## Symbols glossary (TT)

	Smeg Active Ion system improves the quality of the air inside the cell. Thanks to the generation of negatively charged ions released inside the fridge Active Ion system neutralizes unpleasant dust.		The automatic defrost system works by automatically defrosting at regular intervals eliminating the need to defrost altogether.
	Child lock: some models are fitted with a device to lock the programme/cycle so it cannot be accidentally changed.		LED display: to show programmes, functions and options selected and the time to the end of the cycle.
	Economical mode: Analyzes fridge functioning during the activation and optimizes the operating cycle in order to reduce power consumption.		Energy efficiency class E
	Ventilated: Forced distribution of cold air in the refrigerator compartment, which allows even temperature distribution within the fridge.		Fast freezing: The fast freezing function brings the temperature of the compartment down when activated a few hours prior to usage.
	Power saving mode: The power saving mode allows you to disable the refrigerator and keep the freezer working.		LED interior lighting: is a more energy efficient and long lasting way of illuminating the interior of the appliance.
	Life Plus 0°C: The temperature in the Lifeplus compartments is kept at 0°C, which preserves fresh meat and fish longer.		Air plus: keeps food fresher for longer.
	Natural Plus Blu Light: This unique Natural Plus Blu Light system works with nature to increase the storage time of fruit and vegetables.		No Frost: The No Frost and Frost free systems prevent ice from forming so that no defrosting is required.