

S4C122E

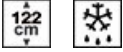

Product Family	Refrigerator
Installation	Built-in
Category	One Door
Built-in niche	122
Reference width	Until 60
Reference height	100 - 160
Cooling type	Static
Defrost	Automatic for refrigerator, manual for freezer
Hinge type	Sliding
Hinge position	Right
Reversible door	Yes
EAN code	8017709337124



Aesthetics

Aesthetic	Universale	Side colour	White
Colour	White	Logo	Silk screen
Material	Metal sheet	Door shelves profile color	White
Side material	Steel	Color of glass shelf profile	White

Refrigerator compartment features



No. of adjustable shelves	3	Type of crisper/vegetable drawers cover	Glass
Number of fruit and vegetables drawers	2	No. of lights refrigerator compartment	1
Type of adjustable shelves	Glass	Internal light in fridge	Yes
Type of crisper/vegetable drawers cover	Standard	Type of internal light (fridge)	LED
Crisper Cover	Yes		

Refrigerator Inner Door

No. of door shelves with transparent cover	1	No. of bottle shelves	1
Number of adjustable door shelves	2		

Other Refrigerator features

Accessories Egg tray

Freezer compartment features

Internal freezer compartment Yes

Other technical features

Type of temperature control	Electro-mechanical
No. of compressors	1
Refrigerant gas type	R600a
Type of compressor	Standard
Refrigerant Quantity (gr)	38 g
Foam agent	Cyclopentane

Performance / Energy Label NEW 2019



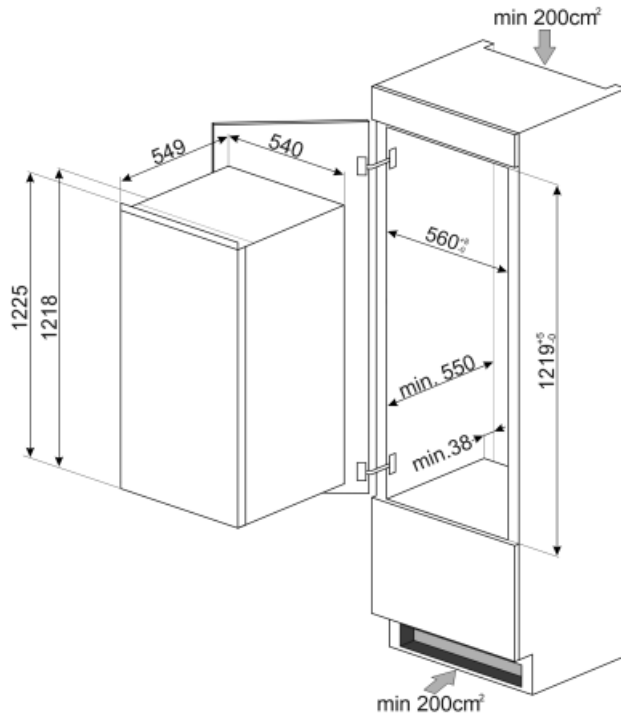

			
Annual energy consumption	146 kWh/a	Airborne acoustical noise emissions	35 dB(A) re 1pW
Energy efficiency class	E	Temperature Rise Time	8.00 h
Airborne acoustical noise emission class	B	4 star - Freezing capacity	2.7 Kg/24h
Total net volume	188 l	Climate class	SN, N, ST, T
Sum of the volumes of the frozen compartment(s)	14 l	EI	100 %
Sum of the volumes of the chill compartment(s) and the unfrozen compartment(s)	174 l		

Electrical Connection

Plug	(F;E) Schuko	Voltage (V)	230-240 V
Electrical connection rating	130 W	Frequency (Hz)	50 Hz
Current	1 A	Power supply cable length	240 cm



Symbols glossary (TT)

- | | | | |
|--|---|---|---|
|  | 4 stars freezing compartment for better food preservation. |  | The automatic defrost system works by automatically defrosting at regular intervals eliminating the need to defrost altogether. |
|  | LED interior lighting: is a more energy efficient and long lasting way of illuminating the interior of the appliance. |  | Built-in niche |
|  | Energy efficiency class E | | |