

S4C092E



Product Family	Refrigerator
Installation	Built-in
Category	One Door
Built-in niche	88
Reference width	Until 60
Reference height	Until 100
Cooling type	Static
Defrost	Automatic for refrigerator, manual for freezer
Hinge type	Sliding
Hinge position	Right
Reversible door	Yes
EAN code	8017709337087



Aesthetics

Aesthetic	Universale	Side colour	White
Colour	White	Logo	Silk screen
Design	Flat	Door shelves profile color	White
Material	Metal sheet	Color of glass shelf profile	White
Side material	Steel		

Refrigerator compartment features



No. of adjustable shelves	2	Crisper Cover	Yes
Number of fruit and vegetables drawers	1	Type of crisper/vegetable drawers cover	Glass
Type of adjustable shelves	Glass	Internal light in fridge	Yes
Type of crisper/vegetable drawers cover	Standard	Type of internal light (fridge)	LED

Refrigerator Inner Door

No. of door shelves with transparent cover	1	No. of bottle shelves	1
Number of adjustable door shelves	2		

Other Refrigerator features

Accessories Egg tray

Freezer compartment features

Internal freezer compartment Yes

Other technical features

Freezer compartment accessories	Ice cube tray
Type of temperature control	Electronic
No. of compressors	1
Refrigerant gas type	R600a
Type of compressor	Standard
Refrigerant Quantity (gr)	31 g
Foam agent	Cyclopentane

Performance / Energy Label NEW 2019





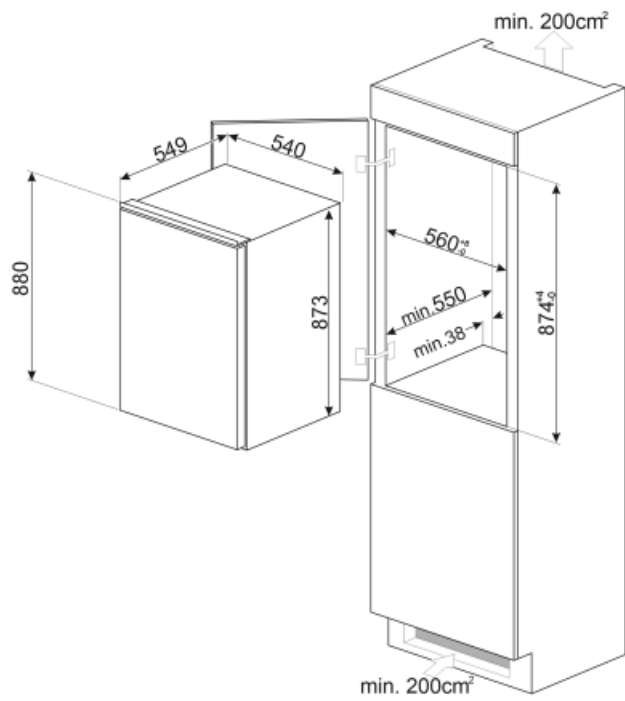

			
Annual energy consumption	143 kWh/a	Airborne acoustical noise emissions	36 dB(A) re 1pW
Energy efficiency class	E	Temperature Rise Time	9.50 h
Airborne acoustical noise emission class	C	4 star - Freezing capacity	2.6 Kg/24h
Total net volume	110 l	Climate class	SN, N, ST
Sum of the volumes of the frozen compartment(s)	14 l	EEl	100 %
Sum of the volumes of the chill compartment(s) and the unfrozen compartment(s)	110 l		

Electrical Connection

Plug	(F;E) Schuko	Voltage (V)	230-240 V
Electrical connection rating	100 W	Frequency (Hz)	50 Hz
Current	0.6 A	Power supply cable length	240 cm



Symbols glossary (TT)

	4 stars freezing compartment for better food preservation.		The automatic defrost system works by automatically defrosting at regular intervals eliminating the need to defrost altogether.
	E: Product energy rating		LED interior lighting: is a more energy efficient and long lasting way of illuminating the interior of the appliance.
	Built-in niche		Energy efficiency class E