

KV194G



| | |
|----------------------|----------------------|
| Product family | Hood |
| Hood Type | Decorative wall hood |
| Design | Angled |
| Extraction | Extraction |
| Electronic control | Yes |
| Perimeter extraction | Yes |
| Material | Glass |
| EAN code | 8017709327897 |
| Hood width | 90 cm |







Aesthetics

| | | | |
|-----------|--------------|-------------------|-------------|
| Aesthetic | Linea | Glass Type | Black |
| Colour | Neptune Grey | Serigraphy colour | Grey |
| Finishing | Glass | Logo | Silk screen |

Controls

| | | | |
|-----------------|-------------------------------------|-----------|-------|
| Control setting | Touch control back-lighted White | Led color | White |
|-----------------|-------------------------------------|-----------|-------|

Programme / Functions

| | |
|-------------------------|---|
| No. of speeds | 3 |
| Intensive speed |  |
| 24h air filter function |  |
| Time-setting options |  |
| Auto-vent 2.0 |  |

Technical Features

| | | | | |
|--|---------------|-------|---------------------------|-----------------|
|       | No. of lights | 2 | Anti-grease filters | Stainless steel |
| | Light type | LED | Charcoal filters included | Yes |
| | Light Power | 2.1 W | | |

| | | | |
|-------------------------------|-----------------------|------------------------------------|--------|
| Dimmer mode | Yes | Filter replacement indicator | Yes |
| Light color temperature range | 2700° - 4000° °K | Vent outlet | 150 mm |
| Free outlet maximum capacity | 820 m ³ /h | Minimum distance from GAS hob | 650 mm |
| Motor power | 275 W | Minimum distance from ELECTRIC hob | 450 mm |
| No. of filters | 2 | Non return valve | Yes |

| | Extraction rate IEC 61591 [m ³ /h] | Noise level IEC 60704-2-13 [dB(A)] |
|-----------------|---|------------------------------------|
| Speed 1 | 277 | 50 |
| Speed 2 | 406 | 63 |
| Speed 3 | 636 | 70 |
| Intensive speed | 782 | 72 |

Performance / Energy Label

A*

| | | | |
|---|-----------------------|--|-----------------------|
| Annual Efficiency Consumption (AEChood) | 41 kWh/a | Airborne acoustical A-weighted sound Power Emission at maximum speed (SPEmax) | 71 dB(A) |
| Energy efficiency class (EEC) | A+ | Airbourne acoustical A-weighted sound power emission at boost speed (SPEboost) | 72 dB(A) |
| Fluid Dynamic Efficiency (FDE) | 36.2 | Power Consumption in Off mode (Po) | 0.49 W |
| Fluid Dynamic Efficiency class (FDEC) | A | Power consumption in stand-by mode (Ps) | 0.99 W |
| Lighting Efficiency (LE) | 34.8 lux/W | Time increase factor (F) | 0.7 |
| Lighting Efficiency Class (LEC) | A | Energy Efficiency Index | 41.2 |
| Grease Filtering Efficiency (GFE) | 64.3 % | Measured air flow rate at best efficiency point (Qbep) | 403 m ³ /h |
| Grease Filtering Efficiency Class (GFEC) | E | Measured air pressure at best efficiency point (Pbep) | 479 Pa |
| Air flow at minumum speed (Qmin) | 277 m ³ /h | Measured electric power input at best efficiency point (Wbep) | 148 W |
| Air flow at maximum speed (Qmax) | 636 m ³ /h | Nominal Power consumption of the light system (WL) | 5 W |
| Air flow at boost speed (Qboost) | 782 m ³ /h | Average illumination of the light on the cooking surface (Emiddle) | 139 lux |
| Airbourne acouistical A-weighted sound Power Emission at minimum speed (SPEmin) | 50 dB(A) | Sound power level at highest setting (Lwa) | 71 dB(A) |

Electrical Connection

Electrical connection rating 279 W
Voltage 220-240 V

Frequency (Hz) 50-60 Hz
Power supply cable length 1500 mm

Also available

Alternative colours available Black

Available colours KV194B3

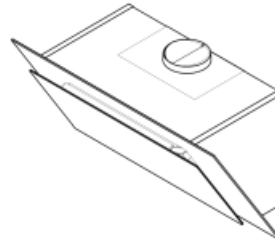
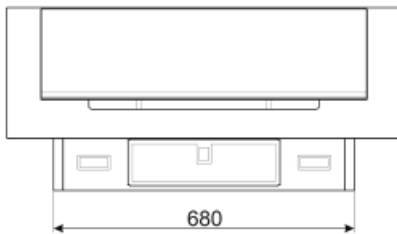
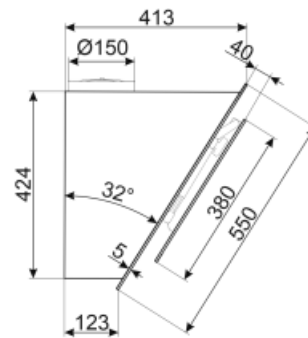
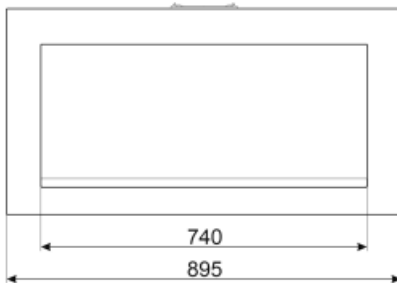

Not included accessories



KITCMNKVX

Chimney Extension in Stainless Steel for hood KV*series 300 mm*200 mm + 500/850 mm



KITALLFC

Universal Charcoal filter Stainless Steel AISI 304 The filter can be washed in dishwasher 50 °C (water and suitable detergent) and to dry it put in the oven 180°C 25 minutes



KITFCKV1













Kit 2 pcs Charcoal Filter for Hood KV1*series. Dishwasher-safe. Size 320x80 mm and 280 x280 mm.



KITCMNKVMB

Chimney Extension in Stainless Steel for hood KV*series 300 mm*200 mm + 500/850 mm

Symbols glossary (TT)

| | | | |
|--|---|---|--|
|  | 24h: When selected this function refreshes the air for c. 10 minutes every hour over a 24 hour period, at minimum speed and an imperceptible noise level. |  | Filters: Model has filters to help remove grease from the steam emanating from the pans during cooking. |
|  | Connection between hob and hood |  | Switch off automatically: A special setting, to run after the end of cooking for a pre-set time and then switch off automatically. |
|  | Charcoal filters: Extracting through charcoal filters or directly to the exterior lessens strong cooking odours considerably. |  | Dimmering Lights |
|  | A+: Energy efficiency class A+ helps to save up to 10% energy compared to class A. Maximum performance with minimum consumption is guaranteed. |  | Warning light(s): to advise when filters need changing. |
|  | Lights: All cooker hoods feature lights to illuminate the cooking area or add to the ambience of the kitchen. |  | Perimeter extraction panels: very efficient and aid noise reduction. |
|  | Intensive/turbo setting: when extra fast extraction is required. |  | Tunable white from warm to cold |