

# STL362DQ



<b>Product Family</b>	Dishwashers
<b>Width</b>	60 cm
<b>Commercial height</b>	82 cm
<b>Installation</b>	Fully-integrated built-in
<b>Kitchen panel</b>	Not supplied
<b>N° baskets</b>	3, Flexi
<b>Motor</b>	Inverter 2.0
<b>EAN code</b>	8017709337353



## Programs / Functions



<b>No. of programmes</b>	8	<b>ECO</b>	Yes
<b>Washing temperatures</b>	50, 60 °C	<b>Mix</b>	Yes
<b>Soak</b>	Yes	<b>Self clean</b>	Yes
<b>Full express - 60 minutes</b>	Yes	<b>Intense 60°</b>	Yes
<b>Express 50°</b>	Yes	<b>Auto 50°-60°</b>	Yes

## Options



<b>Delay timer option</b>	Up to 24 hours, with automatic soak	<b>Crystal option</b>	Yes
<b>Extreme option</b>	Yes	<b>Sterilise option</b>	Yes

## Baskets

	<b>Basket colour</b>	Grey	<b>Largest loadable dish in upper basket</b>	19,0 cm
	<b>Basket components colour</b>	Grey	<b>Lower Basket</b>	With 2 foldable racks
	<b>Handle</b>	In plastic on upper and lower basket	<b>Lower basket with anti-drip inserts</b>	Yes
	<b>Upper Basket</b>	With central fixed racks	<b>Largest loadable dish in lower basket</b>	31.0 cm
	<b>Height adjustment of the upper basket</b>	On two levels (4 cm)		

Colour Inner Components Blue

## Technical Features



Width (mm)	596 mm
Depth (mm)	550 mm
Display type	3 digit
Product Height (mm)	818 mm
Controls	Electronic
Display	Delayed start, Programme time indicator, Time to end indication
Programme graphics	Symbols
On/off indicator	Yes
Salt light indicator	Light
Rinse aid indicator	Light
End of cycle indicator	On display, with acoustic signal
Washing system	Standard
Water softener	With electronic setting
Turbidity sensor Aquatest	Yes
Flood protection system	Total Acquastop

Water supply	Single; cold/hot water max. 60°C - energysave with hot water up to 35%
Max water hardness	90°FH; 50°dH
Drying system	Natural condenser drying, with Dry Assist + automatic door opening system at the end of the cycle
Steam protection	In plastic
Tank material	Stainless steel
Filter	Stainless steel
Concealed heating element	Yes
Hinges	Self balancing, Sliding, FLEXIFIT
Min. and max. frontal panel weight	2 - 10 kg
Min. and max plinth height	40 - 175 mm
Adjustable feet	8cm, from 820 to 900mm
Additional gaskets	Yes
Back cover	Yes
Depth of dishwasher with open door (mm)	1230
Back feet adjustable from front	Yes

## Performance / Energy Label NEW

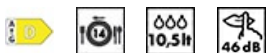

Energy Efficiency Class (Washing cycle)	D
Energy consumption [per 100 cycles, based on the eco programme]	85 kWh
Rated capacity (ps)	14
Water consumption [per cycle]	10,5 litres

Programme duration	4:00 h:min
Airborne acoustical noise emissions (spinning phase)	46 dB(A) re 1 pW
Airborne acoustical noise emission class	C
Energy efficiency Index (EEI) (Washing cycle)	49,9

## Electrical Connection

Plug	(F;E) Schuko	Frequency (Hz)	50 Hz
Connected power	1800 W	Type of connection	Single-phase
Current	10 A		

Voltage







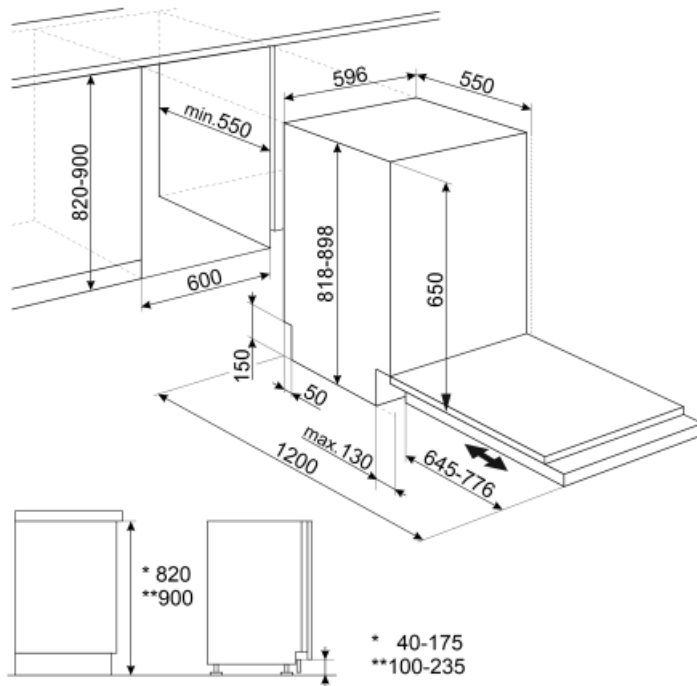













220-240 V

Power supply cable  
length

140 cm



## Symbols glossary

	Aquatest measures the clarity of the water during an auto program, and automatically ensures the minimum consumption of water and energy.		Anti-drip: Some models of dishwashers are equipped with special polymer nozzles anti-drip, that improve the process of drying.
	COMM_HEIGHT_82_72dpi		Delay Timer: The delay timer can postpone the start of the program by up to 24 hours.
	Models with new Flexi Fit hinges are able to be installed in kitchens with a plinth of just 5cms. With this new hinge design, the panel has a sliding movement from the bottom to the top, avoiding any possible interference of the panel with the plinth.		Noise Level: Excellent insulation and special devices keep noise to a minimum.
	Eco: Eco, this economic wash programme uses a low amount of water and energy in order to provide the most environmentally friendly cleaning option.		Normal programme: The normal programme is suitable for normal degrees of dirt for everyday use.
	Soak programme: The soak programme provides a rinse to prevent dirt from drying.		The symbols show the number of plate settings of the dishwasher.
	Total Acquastop: In addition to the partial Acquastop protection present in all Smeg dishwashers, some models have an electronic device fitted to the water intake hose, which monitors water levels in the machine, detects leaks in the hose and switches off the water supply immediately when necessary.		System WaterSave ensures the best washing results with minimal water consumption depending on the model of dishwasher.
	...		...
	...		Wash cycle for normally soiled mixed loads such as dishes and pans, even with dried-on residues. When this program is selected, the dishwasher recognises the type of dirt and automatically adjusts the washing parameters as appropriate.
	This option provides special care for a delicate load. It prevents rapid changes in the wash temperature of the selected programme and reduces it to 4		Programme suitable for washing and drying heavily soiled items with encrusted residues.
	Option which improves the washing results of the selected programme. It increases the wash temperature and duration.		Option which provides better cleaning results by keeping the temperature between 65 and 70°C for at least 10 minutes during the last rinsing phase.
	Energy efficiency class D		The work aimed at continuous improvement has allowed the creation of the second generation of the Inverter motor 2.0, characterised by greater efficiency and durability over time, which allows very high performance and a lower energy consumption and noise level.

