

# STL262D



Product Family	Dishwashers
Width	60 cm
Commercial height	82 cm
Kitchen panel	Not supplied
N° baskets	2
Motor	Inverter 2.0
EAN code	8017709337346



## Programs / Functions



No. of programmes	8	ECO	Yes
Washing temperatures	50, 60 °C	Mix	Yes
Soak	Yes	Self clean	Yes
Full express - 60 minutes	Yes	Intense 60°	Yes
Express 50°	Yes	Auto 50°-60°	Yes

## Options



Delay timer option	Up to 24 hours, with automatic soak	Crystal option	Yes
Extreme option	Yes	Sterilise option	Yes

## Baskets

Basket colour	Grey	Largest loadable dish in upper basket	20,0 cm
Basket components colour	Grey	Lower Basket	With 2 foldable racks
Handle	In plastic on upper and lower basket	Largest loadable dish in lower basket	31.0 cm
Upper Basket	With 1 foldable rack	Colour Inner Components	Grey
Height adjustment of the upper basket	On two levels (4 cm)	Cutlery basket	Yes

## Technical Features



<b>Width (mm)</b>	596 mm
<b>Depth (mm)</b>	550 mm
<b>Display type</b>	3 digit
<b>Product Height (mm)</b>	818 mm
<b>Controls</b>	Electronic
<b>Display</b>	Delayed start, Programme time indicator
<b>Programme graphics</b>	Symbols
<b>On/off indicator</b>	Yes
<b>Salt light indicator</b>	Light
<b>Rinse aid indicator</b>	Light
<b>End of cycle indicator</b>	On display, with acoustic signal
<b>Washing system</b>	Standard
<b>Water softener</b>	With electronic setting
<b>Turbidity sensor</b>	Yes
<b>Aquatest</b>	
<b>Flood protection system</b>	Total Acquastop

<b>Water supply</b>	Single; cold/hot water max. 60°C - energysave with hot water up to 35%
<b>Max water hardness</b>	90°FH; 50°dH
<b>Drying system</b>	Natural condenser drying, with Dry Assist automatic door opening system at the end of the cycle
<b>Steam protection</b>	In plastic
<b>Tank material</b>	Stainless steel
<b>Filter</b>	Stainless steel
<b>Concealed heating element</b>	Yes
<b>Hinges</b>	Self balancing, Sliding, FLEXIFIT
<b>Min. and max. frontal panel weight</b>	2 - 10 kg
<b>Min. and max plinth height</b>	40 - 175 mm
<b>Adjustable feet</b>	8cm, from 820 to 900mm
<b>Additional gaskets</b>	Yes
<b>Depth of dishwasher with open door (mm)</b>	1200
<b>Back feet adjustable from front</b>	Yes

## Performance / Energy Label NEW









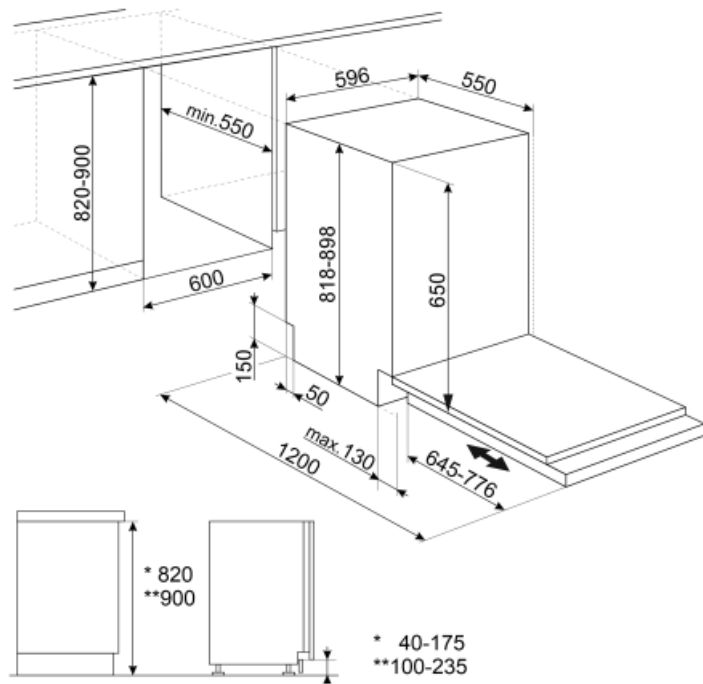













<b>Energy Efficiency Class (Washing cycle)</b>	D	<b>Programme duration</b>	4:00 h:min
<b>Energy consumption [per 100 cycles, based on the eco programme]</b>	84 KWh	<b>Airborne acoustical noise emissions (spinning phase)</b>	46 dB(A) re 1 pW
<b>Rated capacity (ps)</b>	13	<b>Airborne acoustical noise emission class</b>	C
<b>Water consumption [per cycle]</b>	9,9 litres	<b>Energy efficiency Index (EEI) (Washing cycle)</b>	49,9

## Electrical Connection

<b>Plug</b>	(F;E) Schuko	<b>Frequency (Hz)</b>	50 Hz
<b>Connected power</b>	1800 W	<b>Type of connection</b>	Single-phase
<b>Current</b>	10 A	<b>Power supply cable length</b>	140 cm
<b>Voltage</b>	220-240 V		



## Symbols glossary

 <p>Aquatest measures the clarity of the water during an auto program, and automatically ensures the minimum consumption of water and energy.</p>	 <p>COMM_HEIGHT_82_72dpi</p>
 <p>Delay Timer: The delay timer can postpone the start of the program by up to 24 hours.</p>	 <p>Models with new Flexi Fit hinges are able to be installed in kitchens with a plinth of just 5cms. With this new hinge design, the panel has a sliding movement from the bottom to the top, avoiding any possible interference of the panel with the plinth.</p>
 <p>Noise Level: Excellent insulation and special devices keep noise to a minimum.</p>	 <p>Eco: Eco, this economic wash programme uses a low amount of water and energy in order to provide the most environmentally friendly cleaning option.</p>
 <p>Normal programme: The normal programme is suitable for normal degrees of dirt for everyday use.</p>	 <p>Soak programme: The soak programme provides a rinse to prevent dirt from drying.</p>
 <p>The symbols show the number of plate settings of the dishwasher.</p>	 <p>Total Acquastop: In addition to the partial Acquastop protection present in all Smeg dishwashers, some models have an electronic device fitted to the water intake hose, which monitors water levels in the machine, detects leaks in the hose and switches off the water supply immediately when necessary.</p>
 <p>...</p>	 <p>...</p>
 <p>...</p>	 <p>Wash cycle for normally soiled mixed loads such as dishes and pans, even with dried-on residues. When this program is selected, the dishwasher recognises the type of dirt and automatically adjusts the washing parameters as appropriate.</p>
 <p>This option provides special care for a delicate load. It prevents rapid changes in the wash temperature of the selected programme and reduces it to 4</p>	 <p>Programme suitable for washing and drying heavily soiled items with encrusted residues.</p>
 <p>Option which improves the washing results of the selected programme. It increases the wash temperature and duration.</p>	 <p>Option which provides better cleaning results by keeping the temperature between 65 and 70°C for at least 10 minutes during the last rinsing phase.</p>
 <p>Energy efficiency class D</p>	 <p>System WaterSave ensures the best washing results with minimal water consumption depending on the model of dishwasher.</p>



The work aimed at continuous improvement has allowed the creation of the second generation of the Inverter motor 2.0, characterised by greater efficiency and durability over time, which allows very high performance and a lower energy consumption and noise level.