

SI1M4744D

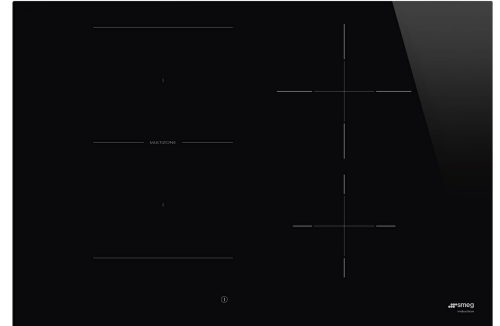

Product Family	Hob
Built-in type	Ultra-low profile or Fully Flushed
Dimensions	70/75 cm
Power supply	Electric
Type	Induction
EAN code	8017709305628



Aesthetics



Aesthetic	Classica
Colour	Black
Finishing	Glass
Material	Glass
Glass type	Ceramic
Glass edge	Straight edge
Type of control setting	Compact Slider Plus
Slider	Yes
LED colours	Red
Control knob position	Front
Serigraphy colour	Grey

Programme / Functions



Total no. of cook zones	4
No. of induction cook zones	4
Time-setting options	Spegnimento automatico
No. of cooking zones with booster	4
No. of Flexible zones	1
Main on/off switch	Yes
Power levels	9
Auto-vent 2.0	Sì

Options



Multizone Option	Yes	End of cooking alarm	Yes
Flexible Zone Type	MultiZone	Residual time indicator	Yes
Worktop Cut-Out	478-482x555-560 mm	Limited Power	Si Advance
Auto Multizone	Yes	Consumption Mode	
Double Booster	Yes	Limited Power	2400 a 7400 - step 100 W
Keep warm automatic function	Yes	Consumption Mode in W	
Grill function	Yes	Showroom Demo Option	Yes
End cooking timer	4	Control Lock / Child Safety	Yes
Pause option	Yes	Bridge option	Yes
Minute minder	1	Cleaning option	Yes
		Quick start	Yes
		Rapid level selection	Yes

Technical Features



Front-left - Induction - Multizone - 2.10 kW - Booster 2.50 kW - 21.8x18.0 cm
 Rear-left - Induction - Multizone - 2.10 kW - Booster 2.50 kW - Double booster 3.00 kW - 21.8x18.0 cm
 Rear-right - Induction - Single - 2.30 kW - Booster 3.00 kW - Double booster 3.00 kW - - Ø 21.0 cm
 Front-right - Induction - Single - 1.40 kW - Booster 2.10 kW - - Ø 16.0 cm
 Multizone left - Booster 3.70 kW - 38.5x23.0 cm

Automatic setting according to pan dimension	Yes	Automatic switch off when overflow	Yes
pan detection	Yes, min 7 cm	Residual heat indicator	Yes
Permanent Automatic Pot Detection with indication of the relative control	Yes	Eco-Heat	Yes
Minimum pan diameter indication	Yes	Protection against accidental start up	Yes
Automatic switch off when overheat	Yes		

Electrical Connection

Electrical connection rating (W)	7400 W	Additional connection modalities	Yes, Double and Three Phase
Current	33 A	Frequency (Hz)	50/60 Hz
Voltage (V)	220-240 V	Power supply cable length	120 cm
Voltage 2 (V)	380-415 V	Terminal box	5 poles
Type of electric cable installed	Yes, Single phase		

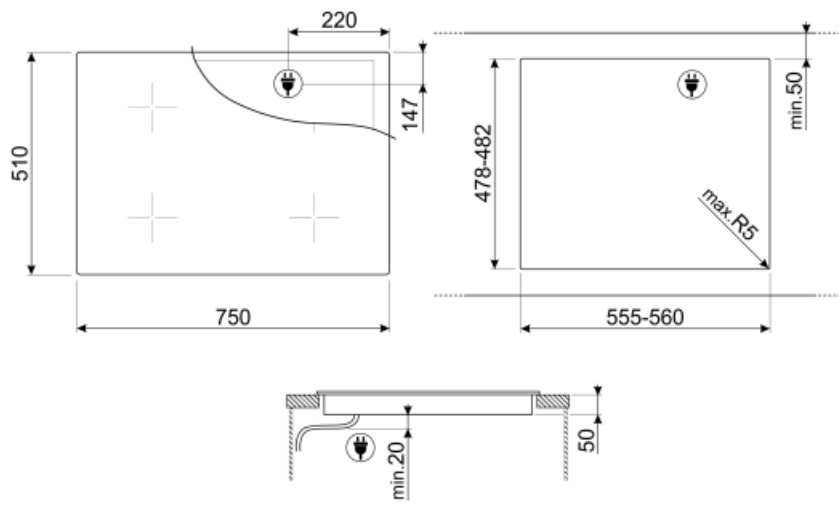

Not included accessories



GRILLPLATE

Universal griddle for induction, gas, ceramic and electric hobs. Non-stick surface ideal for cooking meat, cheese and vegetables. Dimensions: 410 x 240 mm.



TPKPLATE

























Universal plate for induction, gas, ceramic and electric hobs. Non-stick surface ideal for cooking fish, eggs and vegetables. Dimensions: 410 X 240 mm.



SCRP

Non-scratch hob scraper - suitable for induction and ceramic hobs

Symbols glossary (TT)

	Automatic merge of zones for a bigger area		Permanent auto pot detection
	Connection between hob and hood		Power booster: option allows the zone to work at full power when very intense cooking is necessary.
	Child lock: some models are fitted with a device to lock the programme/cycle so it cannot be accidentally changed.		Compact Slider back-lighted ghost effect
	The slider control panel allows you to adjust the power simply by passing your finger across the touch device.		CUT_OUT_STANDARD_72dpi
	Eco-Heat: this function warns when the zone is still hot after being switched off. As well as ensuring maximum safety by preventing burns, this also allows you to make use of residual heat to continue cooking or keep foods hot.		This function allows you to keep cooked food warm without burner it
	Overheat protection: The safety system that automatically turns off the hob in case of overheating of the control unit.		Induction: The work of these hobs is based on the principle of electromagnetic induction. The heat is generated directly in the bottom of the pan during its contact with the hob.
	Multizone: allows several pans to be used at once, large or small, offering freedom of placement and greater flexibility		Overfill protection: The special overfill protection shuts down the stove in the presence of overflow of liquids.
	All cooking zones can be reduced to the minimum power level, so the hob can be left unattended for a short period without food overcooking or burning. Then just press again this function, the previously set power levels can be reactivated.		Quick selection, with one touch cooking begins at the highest level, then automatically reduces after time. Ideal for dishes that require quick boiling and then continued cooking without constant control (eg beef broth).
	Quick Start function: the chosen temperature is reached faster. The heating element works at maximum power until the right temperature is reached.		Indication of residual heat: After the glass ceramic hob is switched off the residual heat indicator shows which of the heating zones still remains hot. When the temperature drops below 60 ° C, the indicator goes out.
	Time elapsed: shows how long the cooking zone has been in use.		Timer: All ceramic hobs have a timer which automatically ends cooking after a preset time.
	TWIN_ZONE_72dpi		Grill function
	Min diameter pot detection of 7 cm		Possibility to set the maximum power absorption of the hob
	Additional maximum power level for a better energy consumption		