

VZUM3434N

Sink material Composite
 Type Composite sink
 No. of bowls 2
 EAN code 8017709213640



Aesthetics



Aesthetic Universale
Serie Quadra
Colour Black
Building in type Undermount

Logo On overflow
Alternative colours available White, Cream, Beige, Cemento / Concrete, EXTRA White, EXTRA Black
Tap hole / precut tap hole No Taphole

	Bowl type RH	Bowl dimensions, WxDxH (mm)	Bowl depth (mm)	Radius corner right bowl (mm)	Overflow LH bowl	Strainer position	Strainer dimension
RH Bowl	Minimum radius	343 x 395 x 220	220	5		Wall position	3.5"
LH Bowl	Minimum radius	343 x 395 x 220	220	5	Yes, traditional	Side bowl	3.5"

Technical Features



Characteristics composite material Antibacterial, Anti-scratch, Thermal shock resistant, High temperatures resistant, Impact resistant, Easy to clean, UV Resistant

Base unit size 80 cm
Tap hole diameter 35 mm
Dividing wall width 34 mm
No. of clips 6
Type of clips Undermount clip

Frame depth (mm) 14

Dimensions of the product (mm)	235x760x435 mm
Cutout dimension undermount (mm)	720 x 395 mm
Undermount cutout radius	5 mm

Accessories Included

Accessories for installation	Strainer, Savespace siphon with dishwasher outlet connection, Fixing clips
------------------------------	--

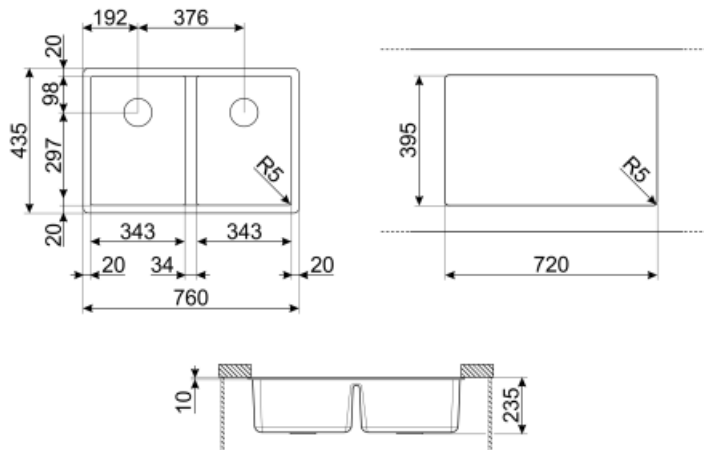

Not included accessories



KITFD050

Waste disposal 0,5 HP, Motor: 1/2 horsepower, Fits all sinks with 3 1/2" waste outlet



KITFD100

Waste disposal 1 HP, Motor: 1/2 horsepower, Fits all sinks with 3 1/2" waste outlet



KITDSQ

Soap dispenser chrome finishing with square knob 40x40 mm



KITFD075

Waste disposal 0,75 HP, Motor: 1/2 horsepower, Fits all sinks with 3 1/2" waste outlet



DBSINT34

St/steel drain basket to fit STD radius composite sinks 340 x 400 mm bowl, 180 mm depth

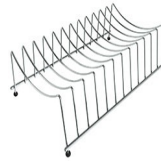

COLPTX











Draining rack base 300 x 185 x 82 mm



CB28QU

Single HPL chopping board for minimum radius, oak, measures 280 x 418 H 12 mm

Symbols glossary (TT)

	Antibacterial		Antiscratch
	Cupboard width required for sink installation		Sink depth - depending on the model, the depth can be from 13 to 24,5
	Under table top installation: The sink is fixed under tabletop, which extends the work surface and the depth of the sink.		Easy to clean
	High temperatures resistant		Impact resistant
	Thermal shock resistant		UV protection, does not fade over time.