

# VZ79N

Sink material Composite  
 Type Composite bowl  
 No. of bowls 1  
 EAN code 8017709183424



## Aesthetics



Aesthetic Universale  
 Serie Quadra  
 Colour Black  
 Building in type Standard

Logo On overflow  
 Alternative colours available White, Cream, Beige, Cemento / Concrete, EXTRA White, EXTRA Black  
 Tap hole / precut tap hole Prepared

	Bowl type	Bowl dimensions, WxDxH (mm)	Bowl depth (mm)	Radius corner bowl	Overflow	Strainer position	Strainer dimension
Bowl	Minimum radius	720 x 400 x 210	210	5	Yes, traditional	Wall position	3.5"

## Technical Features



Characteristics composite material Antibacterial, Anti-scratch, Termal schock resistant, High temperatures resistant, Impact resistant, Easy to clean, UV Resistant

Dimensions of the product (mm) 210x790x500 mm

Cutout dimension topmount (mm) 770 X 480 mm

Height from kitchen top 10 mm

Tap hole 1  
 Tap hole diameter 35 mm  
 No. of clips 10  
 Type of clips Standard

Base unit size 80 cm

## Accessories Included

Accessories for installation

Strainer, Savespace siphon with dishwasher outlet connection, Fixing clips

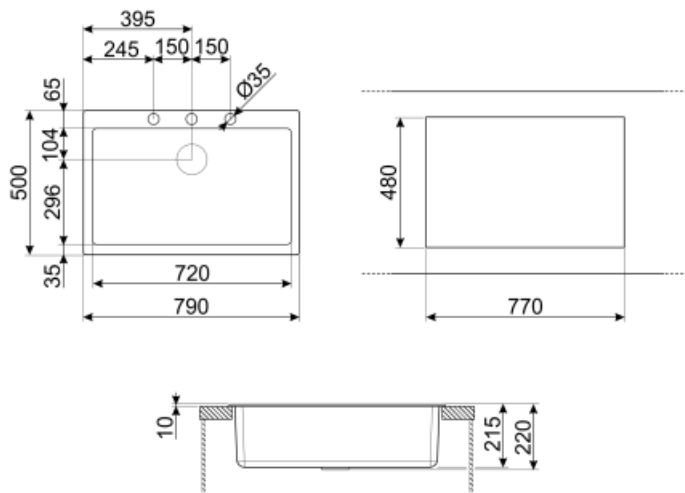

## Not included accessories



### KITFD050

Waste disposal 0,5 HP, Motor: 1/2 horsepower, Fits all sinks with 3 1/2" waste outlet



### KITFD100

Waste disposal 1 HP, Motor: 1/2 horsepower, Fits all sinks with 3 1/2" waste outlet



### COL19H

St/Steel colander to fit MINIMUM radius mm bowl, measures 200 x 410 x 100 mm



### KITDSQ

Soap dispenser chrome finishing with square knob 40x40 mm



### KITFD075

Waste disposal 0,75 HP, Motor: 1/2 horsepower, Fits all sinks with 3 1/2" waste outlet

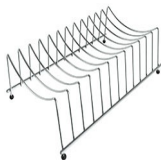

### COLPTX

Draining rack base 300 x 185 x 82 mm



### COL36

St/steel colander for MINIMUM radius bowls, measures 370 x 410 x 30 mm



### MATROL

Stainless steel drainer 405 x 340 mm



### COL19

St/Steel colander to fit MINIMUM radius mm bowl, measures 200 x 410 x 26 mm



### CB25MN

Single HPE chopping board to fit minimum radius bowls, black matt, measures 250 x 410 H 12 mm, dishwasher safe



### DBSINT34

St/steel drain basket to fit STD radius composite sinks 340 x 400 mm bowl, 180 mm depth













### CB28QU

Single HPL chopping board for minimum radius, oak, measures 280 x 418 H 12 mm

## Symbols glossary (TT)

---

	Antibacterial		Antiscratch
	Cupboard width required for sink installation		Sink depth - depending on the model, the depth can be from 13 to 24,5
	Standard installation: Traditional installation in tabletop, suitable for any kitchen sets		Easy to clean
	Thermal shock resistant		High temperatures resistant
	Impact resistant		UV protection, does not fade over time.