

# VZ79CT

Sink material	Composite
Type	Composite bowl
No. of bowls	1
EAN code	8017709251802



## Aesthetics



<b>Aesthetic</b>	Universale	<b>Logo</b>	On overflow
<b>Serie</b>	Quadra	<b>Alternative colours available</b>	Black, White, Cream, Beige, EXTRA White, EXTRA Black
<b>Colour</b>	Cement / Concrete	<b>Tap hole / precut tap hole</b>	Prepared
<b>Building in type</b>	Standard		

	Bowl type	Bowl dimensions, WxDxH (mm)	Bowl depth (mm)	Radius corner bowl	Overflow	Strainer position	Strainer dimension
Bowl	Minimum radius	720 x 400 x 210	210	5	Yes, traditional	Wall position	3.5"

## Technical Features



<b>Characteristics composite material</b>	Antibacterial, Anti-scratch, Termal schock resistant, High temperatures resistant, Impact resistant, Easy to clean, UV Resistant	<b>Tap hole</b>	1
		<b>Tap hole diameter</b>	35 mm
		<b>No. of clips</b>	10
		<b>Type of clips</b>	Standard
<b>Dimensions of the product (mm)</b>	210x790x500 mm		
<b>Cutout dimension topmount (mm)</b>	770 X 480 mm		
<b>Height from kitchen top</b>	10 mm		
<b>Base unit size</b>	80 cm		

## Accessories Included

Accessories for installation

Strainer, Savespace siphon with dishwasher outlet connection, Fixing clips

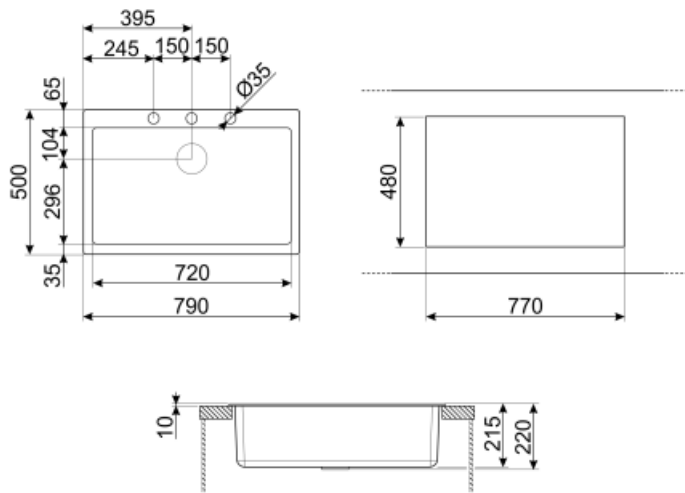

## Not included accessories



### KITFD050

Waste disposal 0,5 HP, Motor: 1/2 horsepower, Fits all sinks with 3 1/2" waste outlet



### KITFD100

Waste disposal 1 HP, Motor: 1/2 horsepower, Fits all sinks with 3 1/2" waste outlet



### COL19H

St/Steel colander to fit MINIMUM radius mm bowl, measures 200 x 410 x 100 mm



### KITDSQ

Soap dispenser chrome finishing with square knob 40x40 mm



### KITFD075

Waste disposal 0,75 HP, Motor: 1/2 horsepower, Fits all sinks with 3 1/2" waste outlet

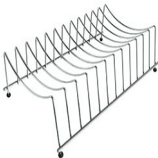

### COLPTX

Draining rack base 300 x 185 x 82 mm



### COL36

St/steel colander for MINIMUM radius bowls, measures 370 x 410 x 30 mm



### MATROL

Stainless steel drainer 405 x 340 mm



### COL19

St/Steel colander to fit MINIMUM radius mm bowl, measures 200 x 410 x 26 mm



### CB25MN

Single HPE chopping board to fit minimum radius bowls, black matt, measures 250 x 410 H 12 mm, dishwasher safe



### DBSINT34

St/steel drain basket to fit STD radius composite sinks 340 x 400 mm bowl, 180 mm depth













### CB28QU

Single HPL chopping board for minimum radius, oak, measures 280 x 418 H 12 mm

---

## Symbols glossary (TT)

---

	Antibacterial		Antiscratch
	Cupboard width required for sink installation		Sink depth - depending on the model, the depth can be from 13 to 24,5
	Standard installation: Traditional installation in tabletop, suitable for any kitchen sets		Easy to clean
	Thermal shock resistant		High temperatures resistant
	Impact resistant		UV protection, does not fade over time.