

VZ79B

Sink material Composite
 Type Composite bowl
 No. of bowls 1
 EAN code 8017709183417



Aesthetics



Aesthetic Universale
Serie Quadra
Colour White
Building in type Standard

Logo On overflow
Alternative colours available Black, Cream, Beige, Cemento / Concrete, EXTRA White, EXTRA Black
Tap hole / precut tap hole Prepared

	Bowl type	Bowl dimensions, WxDxH (mm)	Bowl depth (mm)	Radius corner bowl	Overflow	Strainer position	Strainer dimension
Bowl	Minimum radius	720 x 400 x 210	210	5	Yes, traditional	Wall position	3.5"

Technical Features



Characteristics composite material Antibacterial, Anti-scratch, Termal schock resistant, High temperatures resistant, Impact resistant, Easy to clean, UV Resistant

Dimensions of the product (mm) 210x790x500 mm

Cutout dimension topmount (mm) 770 X 480 mm

Height from kitchen top 10 mm

Tap hole 1
Tap hole diameter 35 mm
No. of clips 10
Type of clips Standard

Base unit size 80 cm

Accessories Included

Accessories for installation

Strainer, Savespace siphon with dishwasher outlet connection, Fixing clips

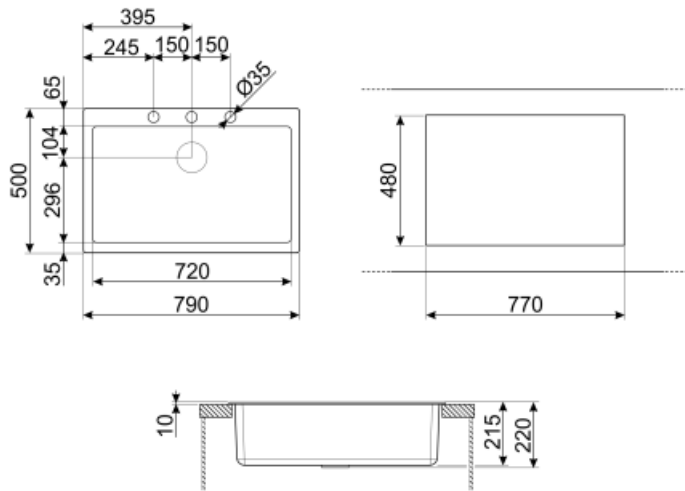

Not included accessories



KITFD050

Waste disposal 0,5 HP, Motor: 1/2 horsepower, Fits all sinks with 3 1/2" waste outlet



KITFD100

Waste disposal 1 HP, Motor: 1/2 horsepower, Fits all sinks with 3 1/2" waste outlet



COL19H

St/Steel colander to fit MINIMUM radius mm bowl, measures 200 x 410 x 100 mm



KITDSQ

Soap dispenser chrome finishing with square knob 40x40 mm



KITFD075

Waste disposal 0,75 HP, Motor: 1/2 horsepower, Fits all sinks with 3 1/2" waste outlet

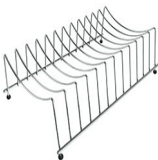

COLPTX

Draining rack base 300 x 185 x 82 mm



COL36

St/steel colander for MINIMUM radius bowls, measures 370 x 410 x 30 mm



MATROL

Stainless steel drainer 405 x 340 mm



COL19

St/Steel colander to fit MINIMUM radius mm bowl, measures 200 x 410 x 26 mm



CB25MN

Single HPE chopping board to fit minimum radius bowls, black matt, measures 250 x 410 H 12 mm, dishwasher safe



DBSINT34











St/steel drain basket to fit STD radius composite sinks 340 x 400 mm bowl, 180 mm depth



CB28QU

Single HPL chopping board for minimum radius, oak, measures 280 x 418 H 12 mm

Symbols glossary (TT)

	Antibacterial		Antiscratch
	Cupboard width required for sink installation		Sink depth - depending on the model, the depth can be from 13 to 24,5
	Standard installation: Traditional installation in tabletop, suitable for any kitchen sets		Easy to clean
	Thermal shock resistant		High temperatures resistant
	Impact resistant		UV protection, does not fade over time.