

VZ3434N

Sink material Composite
 Type Composite sink
 No. of bowls 2
 EAN code 8017709213565



Aesthetics



Aesthetic	Universale	Logo	Applied/on overflow
Serie	Quadra	Alternative colours available	White, Cream, Beige, Cemento / Concrete, EXTRA White, EXTRA Black
Colour	Black	Tap hole / precut tap hole	Prepared
Building in type	Standard		

	Bowl type RH	Bowl dimensions, WxDxH (mm)	Bowl depth (mm)	Radius corner right bowl (mm)	Overflow LH bowl	Strainer position	Strainer dimension
RH Bowl	Minimum radius	343 x 395 x 220	220	5		Wall position	3.5"
LH Bowl	Minimum radius	343 x 395 x 220	220	5	Yes, traditional	Side bowl	3.5"

Technical Features



Characteristics composite material	Antibacterial, Anti-scratch, Thermal shock resistant, High temperatures resistant, Impact resistant, Easy to clean, UV Resistant	Base unit size	80 cm
Frame depth (mm)	10	Tap hole	1
		Tap hole diameter	35 mm
		Dividing wall width	34 mm
		No. of clips	4
		Type of clips	Standard

Dimensions of the product (mm)	235x790x500 mm
Cutout dimension topmount (mm)	770 X 480 mm
Undermount cutout radius	10 mm
Height from kitchen top	10 mm

Accessories Included

Accessories for installation	Strainer, Savespace siphon with dishwasher outlet connection, Fixing clips
------------------------------	--

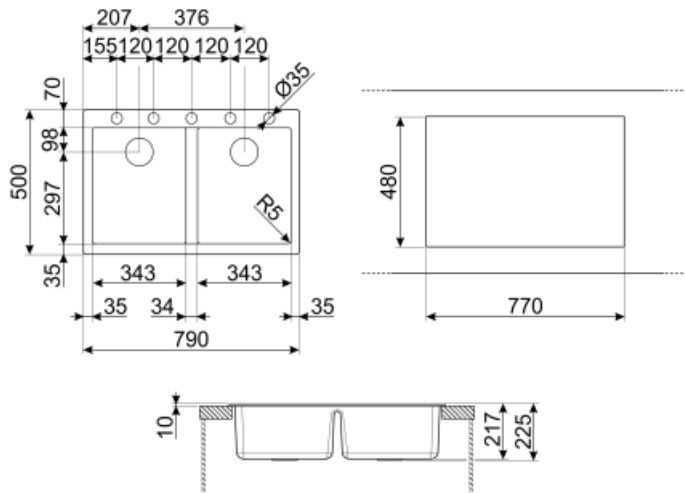

Not included accessories



KITFD050

Waste disposal 0,5 HP, Motor: 1/2 horsepower, Fits all sinks with 3 1/2" waste outlet



KITFD100

Waste disposal 1 HP, Motor: 1/2 horsepower, Fits all sinks with 3 1/2" waste outlet



KITFD075

Waste disposal 0,75 HP, Motor: 1/2 horsepower, Fits all sinks with 3 1/2" waste outlet

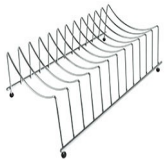

COLPTX

Draining rack base 300 x 185 x 82 mm



COL36

St/steel colander for MINIMUM radius bowls, measures 370 x 410 x 30 mm



KITDSQ

Soap dispenser chrome finishing with square knob 40x40 mm



DBSINT34











St/steel drain basket to fit STD radius composite sinks 340 x 400 mm bowl, 180 mm depth



CB28QU

Single HPL chopping board for minimum radius, oak, measures 280 x 418 H 12 mm

Symbols glossary (TT)

	Antibacterial		Antiscratch
	Cupboard width required for sink installation		Sink depth - depending on the model, the depth can be from 13 to 24,5
	Standard installation: Traditional installation in tabletop, suitable for any kitchen sets		Easy to clean
	High temperatures resistant		Impact resistant
	Thermal shock resistant		UV protection, does not fade over time.