

# VSTR50CUX

Sink material	Stainless steel
Type	Monoblock bowl
No. of bowls	1
EAN code	8017709276850



## Aesthetics



<b>Aesthetic</b>	Universale	<b>Building in type</b>	Undermount
<b>Serie</b>	Mira	<b>Logo</b>	Embossed
<b>Colour</b>	Copper	<b>Tap hole / precut tap hole</b>	No Taphole
<b>Finishing</b>	PVD Brushed		

	Bowl type	Bowl dimensions, WxDxH (mm)	Bowl depth (mm)	Radius corner bowl	Overflow	Strainer position	Strainer dimension
Bowl	Minimum radius	500 x 400 x 200	200	15	Yes, flush fitted	Wall position	3.5"

## Technical Features



<b>Characteristics PVD coating</b>	Coating thickness , Eco-friendly, Easy to clean, Hypoallergenic	<b>Tap hole diameter</b>	35 mm
<b>Dimensions of the product (mm)</b>	200x542x442 mm	<b>No. of clips</b>	8
<b>Cutout dimension undermount (mm)</b>	404*504 mm	<b>Type of clips</b>	Undermount clip
<b>Base unit size</b>	60 cm		

## Accessories Included

Accessories for  
installation

Strainer, Savespace siphon  
with dishwasher outlet  
connection, Fixing clips

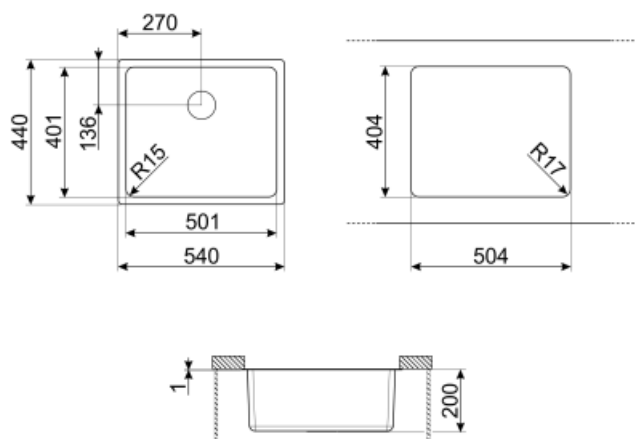

---

## Not included accessories

---



### KITFD050

Waste disposal 0,5 HP, Motor: 1/2 horsepower, Fits all sinks with 3 1/2" waste outlet



### KITFD100

Waste disposal 1 HP, Motor: 1/2 horsepower, Fits all sinks with 3 1/2" waste outlet



### DB34

St/steel drain basket to fit STD radius 340 x 400 bowl, 180 mm depth



### 3712

Siphon single bowl sinks (dishwasher connection included)



### 3713

Siphon double bowls sinks (dishwasher connection included)









### KITFD075

Waste disposal 0,75 HP, Motor: 1/2 horsepower, Fits all sinks with 3 1/2" waste outlet

## Symbols glossary (TT)

---

- |  |   |   |   |
|--|---|---|---|
|  | Cupboard width required for sink installation   |  | Sink depth - depending on the model, the depth can be from 13 to 24,5     |
|  | Under table top installation: The sink is fixed under tabletop, which extends the work surface and the depth of the sink. |  | Easy to clean   |
|  | Coating thickness between 0.2mm and 2mm   |  | PVD coatings are hypoallergenic and suitable for use in contact with food |
|  | The manufacturing process of PVD treatment is 100% green and eco-friendly   |   |   |