

# SBC4304X



Product Family	Blast chiller
Category	45cm compact
Vitality system	Yes
Power supply	Electric
Heat source	Electric
Cooling type	Fan assisted



## Aesthetics

Aesthetic	Classica	Type of steel	Brushed
Colour	Stainless steel	Glass Type	Eclipse
Finishing	Fingerproof	Door	With 2 horizontal strips
Design	Flat	Handle	Classic
Component finish	Stainless steel	Handle Colour	Steel effect
Material	Stainless steel	Logo	Embossed

## Programme / Functions

No. of warming functions	4
Automatic programmes	10
N. cold functions	4
Automatic cleaning	
Customisable recipes	100

## Controls



Display / Clock	TFT graphic , colour touch screen	Control setting	Touch control
-----------------	-----------------------------------	-----------------	---------------

## Options



Door open alarm	Yes	Cooling with probe	Yes
Minute minder	Yes	Showroom demo option	Yes
Timer	2	Tones	Polyphonic
Controls Lock / Child Safety	Yes	Chronology	Yes, the last 10 functions utilized
Cooking with probe thermometer	Yes	Touch guide	Sì, a pressione prolungata su display

## Technical Features

			
Compressor type	Standard	No. of lights	1
Refrigerant gas type	R290	Light type	Halogen
Refrigerant Quantity	58 g	Light Power	1 W
Climatic class	SN, N, ST, T	Light when door is opened	Yes
Temperature control	Electronic	Upper heating element - Power	250 W
Minimum Temperature	-35 °C	Door opening type	Standard opening
Maximum temperature	75 °C	Safety Thermostat	Yes
Cavity material	Stainless steel	Heating suspended when door is opened	Yes
No. of shelves	3	Gross volume	34 l
Shelves type	Metal racks		

## Accessories Included

Grid with back stop	1	Temperature probe	Yes
Bottle rack grid	1	Other	Microfiber cloth

## Electrical Connection



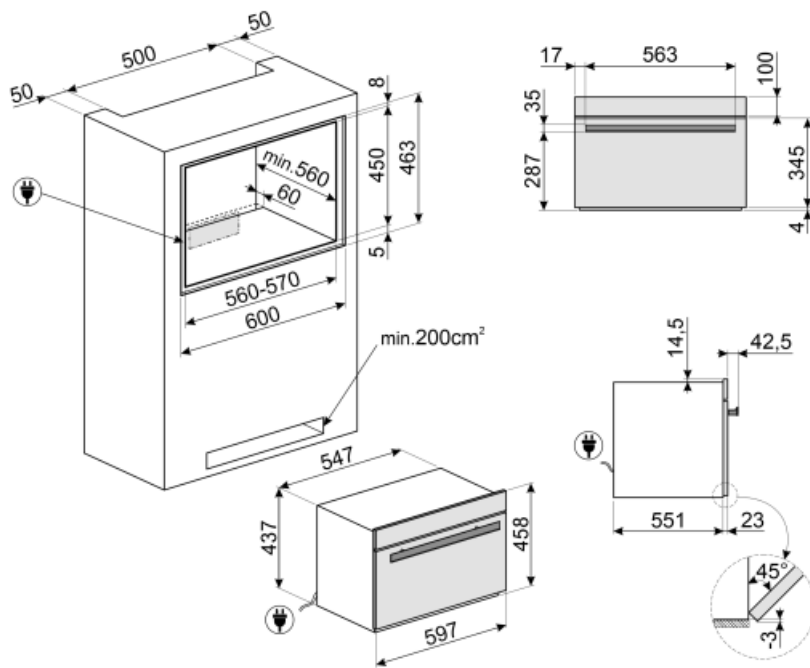



Plug	(F;E) Schuko	Current	2,5 A
Voltage	220-240 V	Frequency (Hz)	50 Hz
Electrical connection rating (W)	270 W	Power supply cable length	200 cm



---

## Symbols glossary (TT)

---

	Child lock: some models are fitted with a device to lock the programme/cycle so it cannot be accidentally changed.		Electric
	Automatic cleaning: a drying cycle of the cavity to be run with the door open, to eliminate any condensation formed during use.		Compact appliances with a height of 45 cm - perfect solution to meet the functional requirements of kitchen sets of small height. Available in several types and in different styles.
	Touch controls: Easy to use touch controls allow the appliance to be programmed at the touch of a button.		The capacity indicates the amount of usable space in the oven cavity in litres.