

SBC4104G



Product Family	Blast chiller
Category	45cm compact
Vitality system	Yes
Power supply	Electric
Heat source	Electric
Cooling type	Fan assisted



Aesthetics

Aesthetic	Linea	Serigraphy colour	Black
Colour	Neptune Grey	Door	Full glass
Finishing	Matt	Handle	Linea minimal
Design	Flat	Handle Colour	Satin metal and black
Material	Glass	Logo	Silk screen
Glass Type	Clear1		

Programme / Functions

No. of warming functions	4
Automatic programmes	10
N. cold functions	4
Automatic cleaning	
Customisable recipes	100

Controls



Display / Clock	TFT graphic , colour touch screen	Control setting	Touch control
-----------------	-----------------------------------	-----------------	---------------

Options



Door open alarm	Yes	Cooling with probe	Yes
Minute minder	Yes	Showroom demo option	Yes
Timer	2	Tones	Polyphonic
Controls Lock / Child Safety	Yes	Chronology	Yes, the last 10 functions utilized
Cooking with probe thermometer	Yes	Touch guide	Sì, a pressione prolungata su display

Technical Features

			
Compressor type	Standard	No. of lights	1
Refrigerant gas type	R290	Light type	Halogen
Refrigerant Quantity	58 g	Light Power	1 W
Climatic class	SN, N, ST, T	Light when door is opened	Yes
Temperature control	Electronic	Upper heating element - Power	250 W
Minimum Temperature	-35 °C	Door opening type	Standard opening
Maximum temperature	75 °C	Safety Thermostat	Yes
Cavity material	Stainless steel	Heating suspended when door is opened	Yes
No. of shelves	3	Gross volume	34 l
Shelves type	Metal racks		

Accessories Included





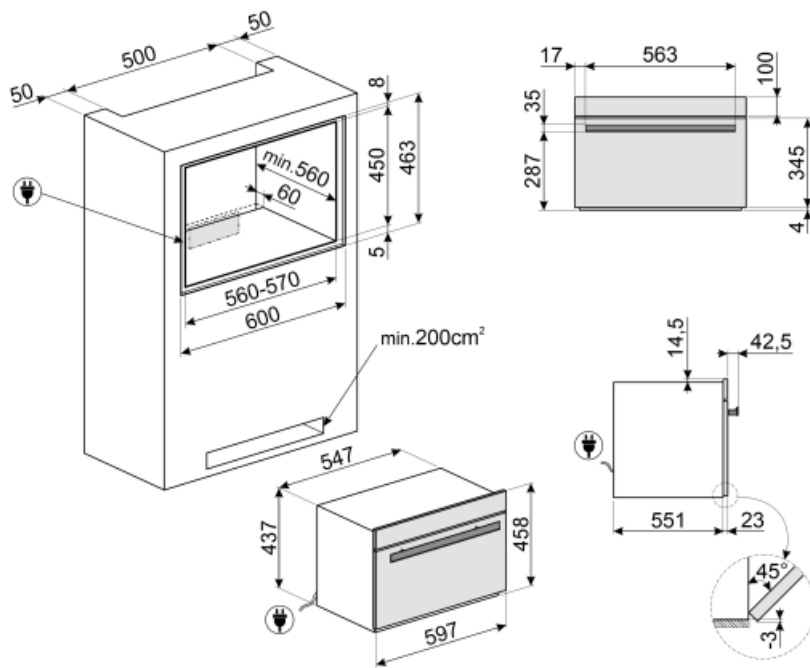

Grid with back stop	1	Temperature probe	Yes
Bottle rack grid	1	Other	Microfiber cloth

Electrical Connection

Plug	(F;E) Schuko	Current	2.5 A
Voltage	220-240 V	Frequency (Hz)	50 Hz
Electrical connection rating (W)	270 W	Power supply cable length	200 cm



Symbols glossary (TT)

- | | | | |
|--|---|---|---|
|  | Child lock: some models are fitted with a device to lock the programme/cycle so it cannot be accidentally changed. |  | Electric |
|  | Automatic cleaning: a drying cycle of the cavity to be run with the door open, to eliminate any condensation formed during use. |  | Compact appliances with a height of 45 cm - perfect solution to meet the functional requirements of kitchen sets of small height. Available in several types and in different styles. |
|  | Touch controls: Easy to use touch controls allow the appliance to be programmed at the touch of a button. |  | The capacity indicates the amount of usable space in the oven cavity in litres. |