

# KSG8P4X



Product family	Hood
Hood Type	Integrated hood
Design	Fully integrated
Extraction	Extraction
Electronic control	Yes
Perimeter extraction	Yes
Material	Stainless steel
Type of steel	Brushed
EAN code	8017709319373
Hood width	75 cm







## Aesthetics

Aesthetic	Universale	Finishing	Satin
Colour	Stainless steel	Logo	Silk screen

## Controls

Control setting	Touch control back-lighted White	Led color	White
-----------------	-------------------------------------	-----------	-------

## Programme / Functions

No. of speeds	3
Intensive speed	
24h air filter function	
Time-setting options	
Auto-vent 2.0	

## Technical Features

    	No. of lights	2	No. of filters	2
	Light type	LED	Anti-grease filters	Aluminium
	Light Power	2,3 W		
	Dimmer mode	Yes		

Light color temperature range	2700° - 4000° °K	Filter replacement indicator	Yes
Free outlet maximum capacity	730 m³/h	Vent outlet	150 mm
Motor power	230 W	Minimum distance from GAS hob	650 mm
		Minimum distance from ELECTRIC hob	650 mm
		Non return valve	Yes

	Extraction rate IEC 61591 [m³/h]	Noise level IEC 60704-2-13 [dB(A)]
Speed 1	266	46
Speed 2	356	52
Speed 3	480	60
Intensive speed	681	67

## Performance / Energy Label

<b>A</b>			
Annual Efficiency Consumption (AEChood)	53 kWh/a	Airborne acoustical A-weighted sound Power Emission at maximum speed (SPEmax)	60 dB(A)
Energy efficiency class (EEC)	A	Airbourne acoustical A-weighted sound power emission at boost speed (SPEboost)	67 dB(A)
Fluid Dynamic Efficiency (FDE)	29,7	Power Consumption in Off mode (Po)	0,49 W
Fluid Dynamic Efficiency class (FDEC)	A	Time increase factor (F)	0,9
Lighting Efficiency (LE)	38,0 lux/W	Energy Efficiency Index	52,5
Lighting Efficiency Class (LEC)	A	Measured air flow rate at best efficiency point (Qbep)	356 m³/h
Grease Filtering Efficiency (GFE)	73,8 %	Measured air pressure at best efficiency point (Pbep)	448 Pa
Grease Filtering Efficiency Class (GFEC)	D	Measured electric power input at best efficiency point (Wbep)	149 W
Air flow at minimum speed (Qmin)	266 m³/h	Nominal Power consumption of the light system (WL)	5 W
Air flow at maximum speed (Qmax)	480 m³/h	Average illumination of the light on the cooking surface (Emiddle)	175 lux
Air flow at boost speed (Qboost)	681 m³/h	Sound power level at highest setting (Lwa)	60 dB(A)
Airbourne acoustical A-weighted sound Power Emission at minimum speed (SPEmin)	46 dB(A)		

## Electrical Connection

Electrical connection rating 235 W  
Voltage 220-240 V

Frequency (Hz) 50-60 Hz  
Power supply cable length 1500 mm

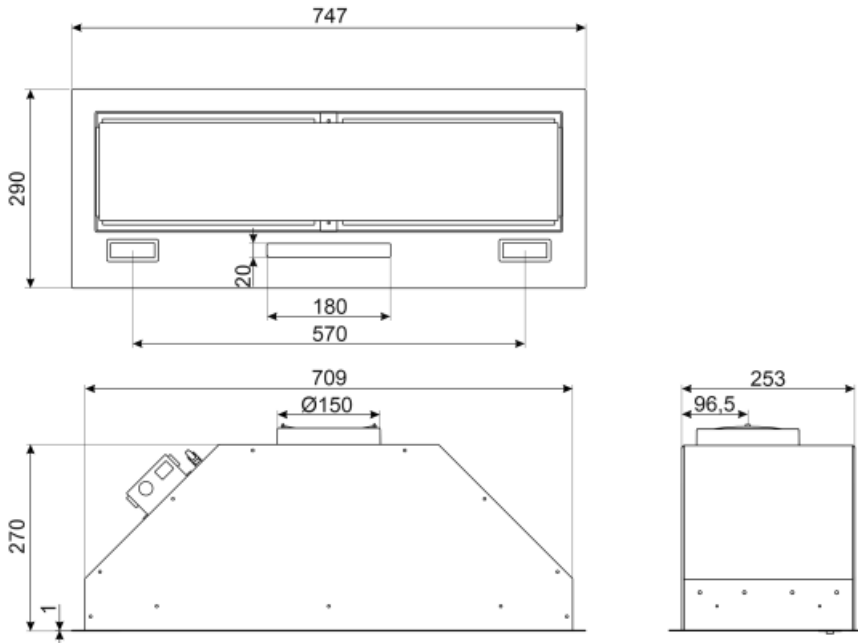

## Not included accessories

---



### FLT6











Round Charcoal filters (kit 2 pieces)



### KITALLFC

Universal Charcoal filter Stainless Steel AISI 304 The filter can be washed in dishwasher 50 °C (water and suitable detergent) and to dry it put in the oven 180°C 25 minutes

## Symbols glossary (TT)

	24h: When selected this function refreshes the air for c. 10 minutes every hour over a 24 hour period, at minimum speed and an imperceptible noise level.		Filters: Model has filters to help remove grease from the steam emanating from the pans during cooking.
	A: Product drying performance, measured from A+++ to D / G depending on the product family		Switch off automatically: A special setting, to run after the end of cooking for a pre-set time and then switch off automatically.
	Connection between hob and hood		Warning light(s): to advise when filters need changing.
	Lights: All cooker hoods feature lights to illuminate the cooking area or add to the ambience of the kitchen.		Perimeter extraction panels: very efficient and aid noise reduction.
	Intensive/turbo setting: when extra fast extraction is required.		Dimmering Lights
	Tunable white from warm to cold		