

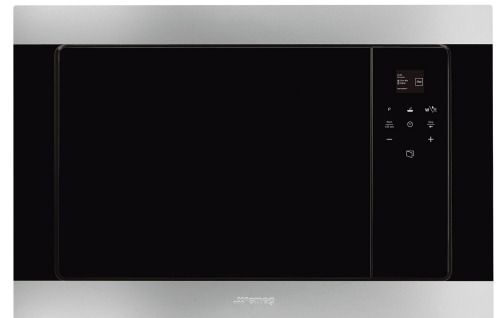





# FMI320X2

<b>Usable volume</b>	20 l
	
<b>Product Family</b>	Microwave
<b>Category</b>	Built-in
<b>Installation</b>	With frame
<b>Power supply</b>	Electric
<b>Cooking Method</b>	Microwave with grill
<b>Control</b>	Electronic



## Programme / Functions

<b>No. of functions</b>	5
<b>Full grill</b>	
<b>Defrost by time</b>	
<b>Defrost by weight</b>	
<b>Microwave</b>	
<b>Microwave + grill</b>	
<b>Automatic programmes</b>	3
<b>Other Microwave functions</b>	Memory

## Controls

	<b>Display / Clock</b>	TFT	<b>Opening</b>	Electrical button
	<b>Type of control setting</b>	Touch control		

## Options

	<b>Timer</b>	Electronic	<b>Showroom demo option</b>	Yes
	<b>Time-setting options</b>	End cooking	<b>Controls Lock / Child Safety</b>	Yes
	<b>End of cooking acoustic alarm</b>	Yes	<b>Quick start option</b>	Yes

Limited Power Consumption Mode Yes

## Technical Features

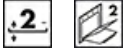

Cavity material	Stainless steel	Grill type	Quartz
No. of shelves/ levels	2	Grill - power	1000 W
Shelves type	Rack	Door opening	Side-opening
No. of lights	1	Total no. of door glasses	2
Light type	Incandescent	Cooling system	Tangential
Light Power	20 W	Microwave screen protection	Yes
Turntable	Yes	Microwave stops when door is opened	Yes
Turntable dimensions	24,5 cm	Usable cavity space dimensions (HxWxD)	210x305x280 mm
Light when door is opened	Yes	Microwave effective power	850 W

## Accessories Included







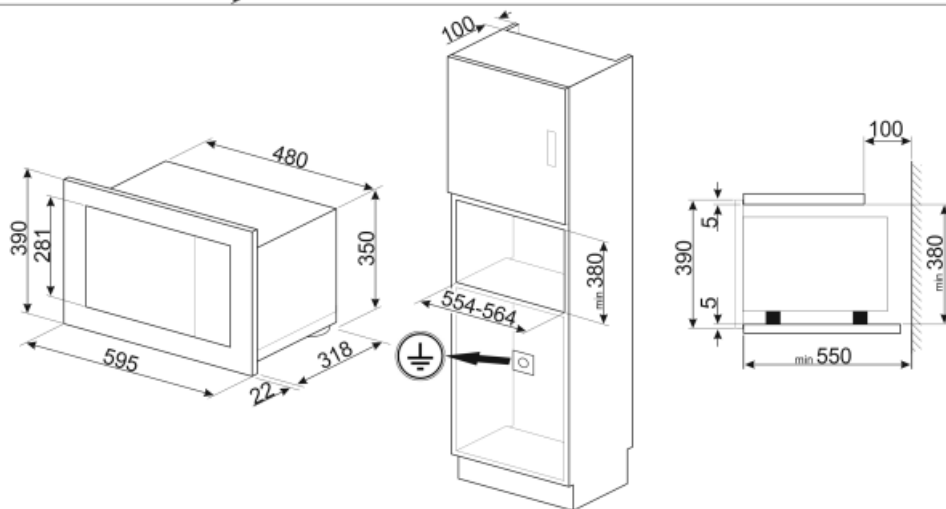
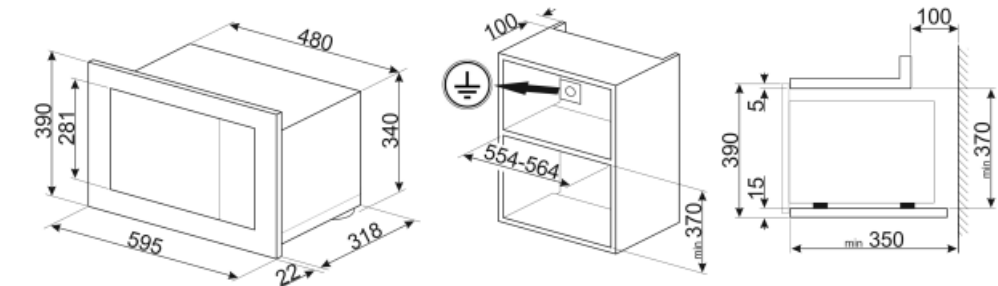



Grid 1 Frame Yes

## Electrical Connection

Nominal power	1300 W	Frequency (Hz)	50 Hz
Current	5,2 A	Power supply cable length	150 cm
Voltage (V)	230 V		



## Symbols glossary (TT)

- |  |  |   |   |
|--|--|---|---|
|    | Child lock: some models are fitted with a device to lock the programme/cycle so it cannot be accidentally changed.   |    | Microwave energy shortens cooking times dramatically and produces energy savings.   |
|    | Defrost by time: Manual defrost function. At the end of the set duration, the function stops.  |    | Defrost by weight: Automatic defrost function. You choose the type of food to defrost from the available categories (MEAT - FISH - BREAD - DESSERTS) After entering the weight of the food, the oven automatically defines the time required for proper defrosting. |
|    | Double glazed doors: Number of glazed doors.   |    | Grill: Very intense heat coming only from above from a double heating element. The fan is not active. Provides excellent grilling and gratinating results. Used at the end of cooking, it gives a uniform browning to dishes.                                       |
|    | Microwave: Penetrating straight into the food, microwaves cook very quickly and with considerable energy savings. Suitable for cooking without fat, they are also able to thaw and heat food without altering its original appearance and aroma. The microwave function can also be combined with conventional functions with all the resulting advantages. Ideal for all types of food. |    | Microwave + grill element: The use of the grill results in a perfect browning of the surface of the food. The action of microwaves allows instead of cooking in a short time the internal part of the food.   |
|  | The oven cavity has 2 different cooking levels.  |  | Touch controls: Easy to use touch controls allow the appliance to be programmed at the touch of a button.   |
|  | The capacity indicates the amount of usable space in the oven cavity in litres.  |   |   |