

FAB38LCR5



Product Family	Refrigerator
Installation	Free standing
Category	Bottom Mount
Reference width	60 - 70
Reference height	Higher than 200
Sistema Total No - Frost	Total
Cooling type	Total No Frost - Double Cooling system
Defrost	Automatic
Hinge type	Standard
Hinge position	Left
EAN code	8017709297862



Aesthetics



Aesthetic	50's Style	Side material	Steel
Colour	Cream	Side colour	Cream
Finishing	Glossy	Logo	Applied
Design	Rounded	Door shelves profile color	Silver
Material	Heat-moulded	Drawers profile color	Silver
Handle	External	Color of glass shelf profile	Silver
Handle type	Fixed	Display	LED
Handle colour	Chrome	Display position	Interno (cella frigo)
Logo colour	Chrome		

Refrigerator compartment features



No. of adjustable shelves	3	Type of crisper/vegetable drawers cover	Glass
Number of fruit and vegetables drawers	1	Life Plus zone-0°C	-2°C +3 °C
Type of adjustable shelves	Glass	Internal light in fridge	Yes
Type of crisper/vegetable drawers cover	On sliding rails	Type of internal light (fridge)	LED
Crisper Cover	Yes		

Refrigerator Inner Door

Number of adjustable door shelves 3

No. of bottle shelves 1

Other Refrigerator features



MultiFlow
Fan

Yes
Yes

Ionizer

Yes

Freezer compartment features

Number of drawers 2
No. of shelves 2

No. of compartments with flap 1

Type of shelves Glass

Other Freezer features



Manual ice maker
Ice maker

Yes
Manual

Fast freezing compartment

Yes

Other technical features



Functions display
Fast freezing button
Temperature alarm lamp
Door open alarm
Temperature Alarm
Type of temperature control
No. of compressors
Refrigerant gas type
Type of compressor
Refrigerant Quantity (gr)
Foam agent

Fast freezing, ECO, Temperature alarm
Yes
Yes
Acoustic and visual
Yes
Electronic
1
R600a
Inverter
45 g
Cyclopentane

Performance / Energy Label NEW 2019



Annual energy consumption 282 kWh/a
Energy efficiency class E
Airborne acoustical noise emission class C
Total net volume 481 l

Airborne acoustical noise emissions 41 dB(A) re 1pW
Temperature Rise Time 14 h
4 star - Freezing capacity 8 Kg/24h
Climate class SN, N, ST, T

Sum of the volumes of the frozen compartment(s) 137 l

EEl

98 %

Sum of the volumes of the chill compartment(s) and the unfrozen compartment(s) 344 l







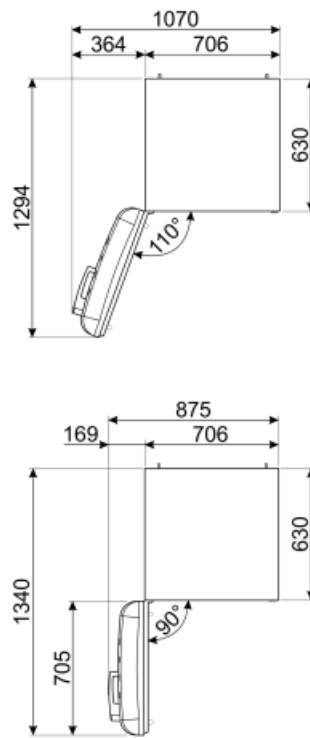
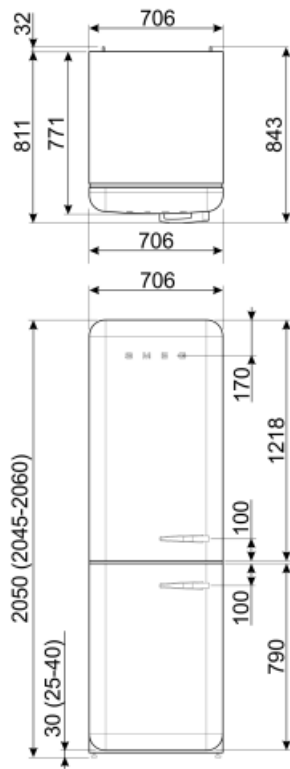





Electrical Connection

Plug (F;E) Schuko
Electrical connection rating 127 W
Current 1.1 A

Voltage (V) 220-240 V
Frequency (Hz) 50/60 Hz
Power supply cable length 180 cm



Symbols glossary (TT)

 <p>4 stars freezing compartment for better food preservation.</p>	 <p>Smeg Active Ion system improves the quality of the air inside the cell. Thanks to the generation of negatively charged ions released inside the fridge Active Ion system neutralizes unpleasant dust.</p>
 <p>The automatic defrost system works by automatically defrosting at regular intervals eliminating the need to defrost altogether.</p>	 <p>LED display: to show programmes, functions and options selected and the time to the end of the cycle.</p>
 <p>Economical mode: Analyzes fridge functioning during the activation and optimizes the operating cycle in order to reduce power consumption.</p>	 <p>Energy efficiency class E</p>
 <p>A++: Energy efficiency class A++ helps to save up to 20% energy compared to class A. Maximum performance with minimum consumption is guaranteed.</p>	 <p>Ventilated: Forced distribution of cold air in the refrigerator compartment, which allows even temperature distribution within the fridge.</p>
 <p>Fast freezing: The fast freezing function brings the temperature of the compartment down when activated a few hours prior to usage.</p>	 <p>LED interior lighting: is a more energy efficient and long lasting way of illuminating the interior of the appliance.</p>
 <p>Life Plus 0°C: The temperature in the Lifeplus compartments is kept at 0°C, which preserves fresh meat and fish longer.</p>	 <p>Smeg's evolution towards more intelligent and eco-friendly models has led to the choice of Inverter technology, which significantly reduces consumption.</p>
 <p>Air plus: keeps food fresher for longer.</p>	