

# FAB38LBL5



<b>Product Family</b>	Refrigerator
<b>Installation</b>	Free standing
<b>Category</b>	Bottom Mount
<b>Reference width</b>	60 - 70
<b>Reference height</b>	Higher than 200
<b>Sistema Total No - Frost</b>	Total
<b>Cooling type</b>	Total No Frost - Double Cooling system
<b>Defrost</b>	Automatic
<b>Hinge type</b>	Standard
<b>Hinge position</b>	Left
<b>EAN code</b>	8017709297855



## Aesthetics



<b>Aesthetic</b>	50's Style	<b>Side material</b>	Steel
<b>Colour</b>	Black	<b>Side colour</b>	Black
<b>Finishing</b>	Glossy	<b>Logo</b>	Applied
<b>Design</b>	Rounded	<b>Door shelves profile color</b>	Silver
<b>Material</b>	Heat-moulded	<b>Drawers profile color</b>	Silver
<b>Handle</b>	External	<b>Color of glass shelf profile</b>	Silver
<b>Handle type</b>	Fixed	<b>Display</b>	LED
<b>Handle colour</b>	Chrome	<b>Display porition</b>	Interno (cella frigo)
<b>Logo colour</b>	Chrome		

## Refrigerator compartment features



<b>No. of adjustable shelves</b>	3	<b>Type of crisper/vegetable drawers cover</b>	Glass
<b>Number of fruit and vegetables drawers</b>	1	<b>Life Plus zone-0°C</b>	Yes
<b>Type of adjustable shelves</b>	Glass	<b>Internal light in fridge</b>	Yes
<b>Type of crisper/vegetable drawers cover</b>	On sliding rails	<b>Type of internal light (fridge)</b>	LED
<b>Crisper Cover</b>	Yes		

## Refrigerator Inner Door

Number of adjustable door shelves	3	No. of bottle shelves	1
-----------------------------------	---	-----------------------	---

## Other Refrigerator features



MultiFlow	Yes	Ionizer	Yes
Fan	Yes		

## Freezer compartment features

Number of drawers	2	No. of compartments with flap	1
No. of shelves	2	Type of shelves	Glass

## Other Freezer features



Manual ice maker	Yes	Fast freezing compartment	Yes
Ice maker	Manual		

## Other technical features



Functions display	Fast freezing, ECO, Temperature alarm
Fast freezing button	Yes
Temperature alarm lamp	Yes
Door open alarm	Acoustic and visual
Temperature Alarm	Yes
Type of temperature control	Electronic
No. of compressors	1
Refrigerant gas type	R600a
Type of compressor	Inverter
Refrigerant Quantity (gr)	45 g
Foam agent	Cyclopentane

## Performance / Energy Label NEW 2019



Annual energy consumption	282 kWh/a	Airborne acoustical noise emissions	41 dB(A) re 1pW
Energy efficiency class	E	Temperature Rise Time	14 h
Airborne acoustical noise emission class	C	4 star - Freezing capacity	8 Kg/24h
Total net volume	481 l	Climate class	SN, N, ST, T

Sum of the volumes of the frozen compartment(s) 137 l

EEl

98 %

Sum of the volumes of the chill compartment(s) and the unfrozen compartment(s) 344 l







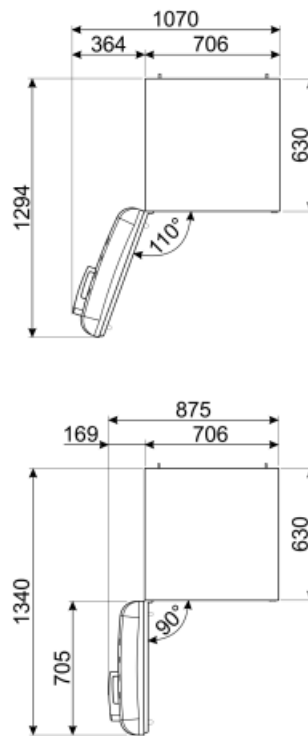
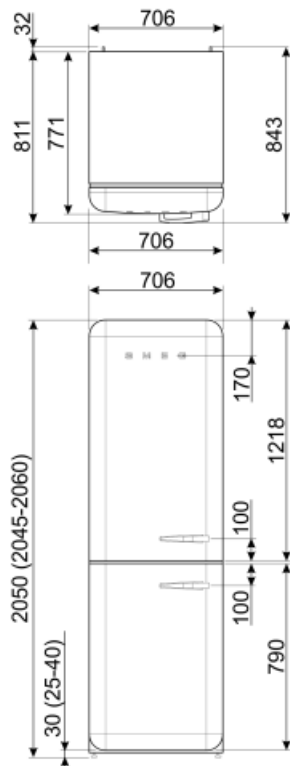





## Electrical Connection

Plug (F;E) Schuko  
Electrical connection rating 127 W  
Current 1,1 A

Voltage (V) 220-240 V  
Frequency (Hz) 50/60 Hz  
Power supply cable length 180 cm



## Symbols glossary (TT)

 <p>4 stars freezing compartment for better food preservation.</p>	 <p>Smeg Active Ion system improves the quality of the air inside the cell. Thanks to the generation of negatively charged ions released inside the fridge Active Ion system neutralizes unpleasant dust.</p>
 <p>The automatic defrost system works by automatically defrosting at regular intervals eliminating the need to defrost altogether.</p>	 <p>LED display: to show programmes, functions and options selected and the time to the end of the cycle.</p>
 <p>Economical mode: Analyzes fridge functioning during the activation and optimizes the operating cycle in order to reduce power consumption.</p>	 <p>Energy efficiency class E</p>
 <p>A++: Energy efficiency class A++ helps to save up to 20% energy compared to class A. Maximum performance with minimum consumption is guaranteed.</p>	 <p>Ventilated: Forced distribution of cold air in the refrigerator compartment, which allows even temperature distribution within the fridge.</p>
 <p>Fast freezing: The fast freezing function brings the temperature of the compartment down when activated a few hours prior to usage.</p>	 <p>LED interior lighting: is a more energy efficient and long lasting way of illuminating the interior of the appliance.</p>
 <p>Life Plus 0°C: The temperature in the Lifeplus compartments is kept at 0°C, which preserves fresh meat and fish longer.</p>	 <p>Smeg's evolution towards more intelligent and eco-friendly models has led to the choice of Inverter technology, which significantly reduces consumption.</p>
 <p>Air plus: keeps food fresher for longer.</p>	