

# FMI125N

Usable volume

25 l



Product Family

Microwave

Category

Built-in

Installation

Fully Built-in

Power supply

Electric

Cooking Method

Microwave with grill

Control

Electronic



## Programs / Functions

No. of functions

6

Full grill



Pizza



Defrost by time



Defrost by weight



Microwave



Microwave + grill



Automatic programmes

8

## Controls



Display / Clock

TFT

Opening

Electrical button

Type of control setting

Touch control

## Options



Timer

Electronic

End of cooking acoustic alarm

Yes

Time-setting options

End cooking

**Controls Lock / Child Safety** Yes

## Technical Features

<b>Cavity material</b>	Stainless steel	<b>Door opening</b>	Side-opening
<b>No. of lights</b>	1	<b>Total no. of door glasses</b>	1
<b>Light type</b>	Incandescent	<b>Safety Thermostat</b>	Yes
<b>Turntable</b>	Yes	<b>Cooling system</b>	Tangential
<b>Turntable dimensions</b>	31.5 cm	<b>Microwave stops when door is opened</b>	Yes
<b>Light when door is opened</b>	Yes	<b>Usable cavity space dimensions (HxWxD)</b>	334x370x221 mm
<b>Grill type</b>	Quartz	<b>Microwave effective power</b>	900 W
<b>Grill - power</b>	1000 W		

## Accessories Included

<b>Grid</b>	1	<b>Other</b>	Suction cup
-------------	---	--------------	-------------

## Electrical Connection



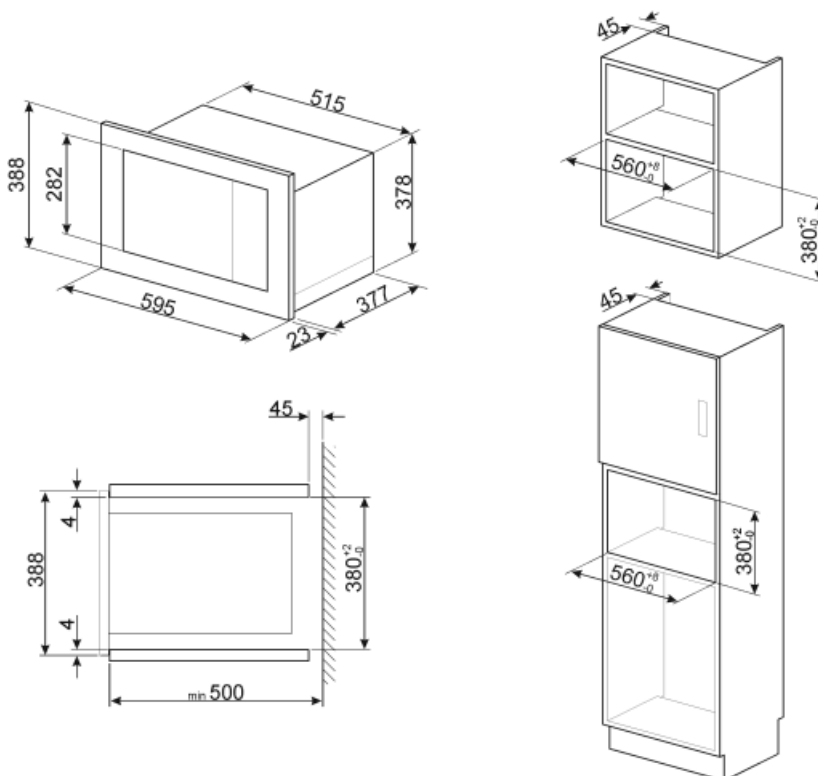







<b>Nominal power (W)</b>	1450 W	<b>Frequency (Hz)</b>	50 Hz
<b>Current</b>	6,3 A	<b>Power supply cable length</b>	130 cm
<b>Voltage (V)</b>	230 V		



---

## Symbols glossary

---

- |  |   |   |  |
|--|---|---|--|
|    | Child lock: some models are fitted with a device to lock the programme/cycle so it cannot be accidentally changed.  |    | Microwave energy shortens cooking times dramatically and produces energy savings.  |
|    | Defrost by time: with this function the time of thawing of foods are determined automatically.  |    | Defrost by weight: With this function the defrosting time is determined  |
|    | Grill element: Using of grill gives excellent results when cooking meat of medium and small portions, especially when combined with a rotisserie (where possible). Also ideal for cooking sausages and bacon. |    | Microwave: Penetrating straight into the food, microwaves cook very quickly and with considerable energy savings. Suitable for cooking without fat, they are also able to thaw and heat food without altering its original appearance and aroma. The microwave function can also be combined with conventional functions with all the resulting advantages. Ideal for all types of food. |
|    | Microwave + grill element: The use of the grill results in a perfect browning of the surface of the food. The action of microwaves allows instead of cooking in a short time the internal part of the food.   |    | Pizza microwave: This function cooks pizza quicker thanks to the microwaves. To optimize the final result, use the function combined with the Chef plate   |
|  | Touch controls: Easy to use touch controls allow the appliance to be programmed at the touch of a button.   |  | The capacity indicates the amount of usable space in the oven cavity in litres.  |