

WNP96SLAAIN













EAN Code	8017709328221
Product Family	Washing Machine
Commercial width	60 cm
Commercial depth	Large capacity
Installation	Free-standing
Load type	Frontal



Programme / Functions

Controls	Electronic
Programmes graphics	Written in EN
Multilanguage clip system	Yes
No. of programmes	14
Programmes	

Eco 40-60	Outdoor	Wool/Hand wash
Self Clean	 Cotton	 Auto Program
 Rinse	 Drain + Spin	 Mix
 Shirts	 Anti-allergy	 Quick Wash 14 min
 Synthetics	 Refresh	
Washing Temperature		
Cool	20°C	30°C
40°C	60°C	90°C
Special programmes		
Outdoor	Refresh	Automatic
 Anti-allergy	 Quick 14 min	

Display

Residual time indicator delay start programme status indication



spin regulation temperature regulation

Display type 

Buttons/Options

End Time Anticrease+ Autodose

Extra Rinse Spin Speed Temperature

 Anti-wrinkle (easy ironing)  Quick  Steam

Programme progress indicator (light) On display

End of cycle indicator (light) On display

Technical Features



Type of motor Brushless/Inverter

Electronic control Yes

functioning

Programme selection Yes

Spin speed selection on No spin/ 600/ 800/ 1200/

display/LED 1600/ Rinse hold

Display/led for Yes

temperature regulation

Polypropilene tank Yes

Basket Stainless steel

Drum capacity 65 l

Liquid detergent Yes

accessory as standard

Door diameter 34 cm

Door opening 160°

Automatic variable load Yes

Antifoam system Yes

Load balancing system Automatic

Easy to access filter Yes

Child lock (functions Control block

block)

Anti-flood system Yes

Performance / Energy Label NEW 2019



Supplier's name or SMEG

trademark

Rated Capacity 9 kg

Energy Efficiency Class A

Energy_cons_100 49 kWh

Water Consumption 43 litres

Spin-drying efficiency A

class

Airbone acoustical noise C

class

Airbone acoustical noise 78 dB(A) re 1 pW

Programme duration at 3:48 h:min

rated capacity

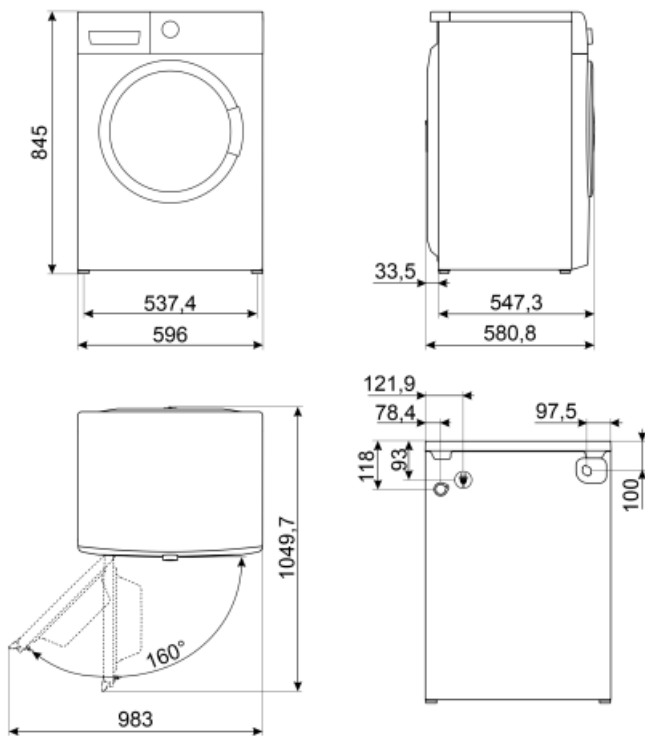



















Not included accessories





KITPLV2

Kit extension for dishwasher and washing machine: lenght mt. 2



Symbols glossary (TT)

 <p>Easy Iron: this is an option which can be selected to ensure the finished laundry is left with less creases to make ironing easier.</p>	 <p>Variable load: In all models of washing machines is present the system of variable load, according to which the machine automatically diversifies the wash cycle and the time of operation depending on the quantity and type of laundry introduced, allowing a significant saving of water and energy power, up to 30% compared to the versions with fixed load.</p>
 <p>Automatic Load Balancing: provides an ideal distribution of laundry in the drum. In case if the imbalance is detected, the rotation speed starts being controlled in such way to evenly redistribute laundry in the drum, and thus reduce vibration.</p>	 <p>Child lock: some models are fitted with a device to lock the programme/cycle so it cannot be accidentally changed.</p>
 <p>LCD display: to optimize performance and simplify the use of the appliance.</p>	 <p>34 cm: Large loading hatch of 34 cm in diameter, makes laundry loading and unloading easier and faster with maximum ease of use.</p>
 <p>This option advises when the periodic cleaning of the filters is needed, in order to avoid forgetfulness and thus guarantee the perfect functioning of the dryer over time. The convenient position of the filters makes maintenance fast and extremely simple.</p>	 <p>Smeg's evolution towards more intelligent and eco-friendly models has led to the choice of Inverter technology, which significantly reduces consumption.</p>
 <p>Antiallergic: Antiallergic program with particular attention to the total removal of residual detergent.</p>	 <p>This cycle automatically select temperature and all the washing parameters.</p>
 <p>Cotton: For soiled fabrics in cotton</p>	 <p>To drain the water in the machine.</p>
 <p>Mixed fabrics: this cycle is designed for lightly soiled laundry in a mix of cottons and synthetics, or can be used just to refresh stored items.</p>	 <p>Super fast 14 min.: a programme designed to wash small amounts of laundry fast, ideal for washing lightly soiled garments.</p>
 <p>Refresh: an ideal program to refresh the garments that have been kept for a long time indoors and eliminate unpleasant odors, without having to wash.</p>	 <p>Extra rinse: The Extra rinse option: can be added to the selected programme when more thorough cleansing of special fabrics is needed.</p>
 <p>Shirts: a cycle to wash shirts in a short time with the utmost care, using a delicate spin for easy ironing.</p>	 <p>Synthetics: to wash your synthetic clothes (shirts, blouses, synthetic/cotton blends, etc.). It washes with a gentle action and has a shorter washing cycle compared to the Cottons programme. For curtains and tulle, use the Synthetic 40°C programme with prewash and anti-creasing functions selected. As their meshed texture causes excessive foaming, wash the veils/tulle by putting little amount of detergent into the main wash compartment. Do not put detergent in the prewash compartment.</p>

-  Option that allow to reduce times of the selected program.
-  Steam Option: the steam is perfect for smoothing out creases, refreshing fabrics, neutralizing odors and releasing dirt, destroying allergens more quickly than by washing the item in water.
-  Volumeplus: Smeg offers models with load up to 8 kg, while maintaining the best washing results, and providing low energy consumption.
-  Drum has maximum capacity of 9kg of dry laundry.
-  Energy efficiency class A