

CPF9GPX

Cooker size	90x60 cm
N. of cavities with energy label	1
Cavity heat source	ELECTRICITY
Hob type	Gas
Type of main oven	Thermo-ventilated
Cleaning system main oven	Pyrolitic
EAN code	8017709225780
Energy efficiency class	A+



Aesthetics













Aesthetic	Portofino	Display	LCD
Colour	Stainless steel	No. of controls	8
Finishing	Satin	Serigraphy colour	Black
Design	Flush fit	Handle	Smeg Portofino
Door	With frame	Handle Colour	Brushed stainless steel
Upstand	Yes	Glass type	Grey
Type of pan stands	Cast Iron	Feet	Black
Hob colour	Stainless steel	Plinth	Black
Command panel finish	Finger friendly stainless steel	Storage compartment	Push pull
Control knobs	Smeg Portofino	Logo	Assembled st/steel
Controls colour	Stainless steel	Logo position	Facia below the oven

Programme / Functions

No. of cooking functions	10
--------------------------	----

Traditional cooking functions

 Static	 Fan assisted	 Circulaire
 Turbo	 Eco	 Small grill
 Large grill	 Fan grill (large)	 Base
 Fan assisted bottom		





Cleaning functions

 Pyrolytic	 Pyrolytic eco
--	---

Automatic programs

20











Other functions

 Defrost by time	 Defrost by weight	 Proving
 Sabbath		

Hob technical features

 UR			
Total no. of cook zones	6		
Front left - Gas - 2UR (dual) - 4.20 kW			
Rear left - Gas - AUX - 1.00 kW			
Front centre - Gas - AUX - 1.00 kW			
Rear centre - Gas - Semi Rapid - 1.80 kW			
Front right - Gas - Semi Rapid - 1.80 kW			
Rear right - Gas - Rapid - 3.00 kW			
Type of gas burners	Standard	Gas safety valves	Yes
Automatic electronic ignition	Yes	Burner caps	Matt black enamelled

Main Oven Technical Features

									
No. of lights	2	Total no. of door glasses	4						
Fan number	3	No. of thermo-reflective door glasses	3						
Net volume of the cavity	115 l	Safety Thermostat	Yes						
Gross volume, 1st cavity	129 l	Heating suspended when door is opened	Yes						
Cavity material	Ever Clean enamel	Cooling system	Tangential						
No. of shelves	5	Door Lock During Pyrolysis	Yes						
Type of shelves	Metal racks								
Light type	Halogen								
Light Power	40 W								

Cooking time setting	Start and Stop	Usable cavity space dimensions (HxWxD)	371x724x418 mm
Light when oven door is open	Yes	Temperature control	Electronic
Door opening	Flap down	Lower heating element power	1700 W
Removable door	Yes	Upper heating element - Power	1200 W
Full glass inner door	Yes	Grill element	1700 W
Removable inner door	Yes	Large grill - Power	2900 W
		Circular heating element - Power	2 x 1850 W
		Grill type	Electric
		Soft Close system	Yes

Options Main Oven

Timer	Yes	Minimum Temperature	50 °C
End of cooking acoustic alarm	Yes	Maximum temperature	260 °C

Accessories included for Main Oven & Hob



Cast iron wok support	1	40mm deep tray	1
Rack with back and side stop	1	Grill mesh	1
20mm deep tray	1	Telescopic Guide rails, partial Extraction	1

Electrical Connection

Electrical connection rating	4000 W	Cable testing	Yes, Single phase
Current	18 A	Additional connection modalities	Yes, Double and Three Phase
Voltage	220-240 V	Frequency	50/60 Hz
Voltage 2 (V)	380-415 V	Terminal block	5 poles
Type of electric cable installed	Yes, Single phase		

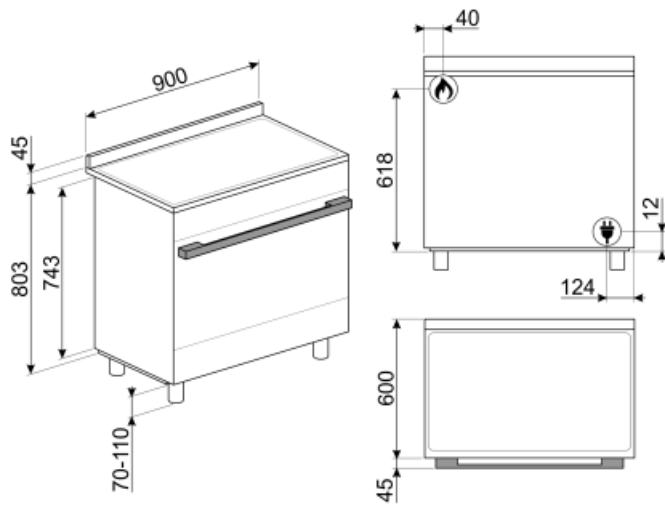

Not included accessories

BGCPF9

Cast iron grill plate suitable for Portofino Cookers

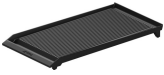

SFLK1

Child lock



PRTX

Refractory pizza stone with handles. D=35cm Not suitable for microwave ovens. Suitable for gas ovens, to be put on the griddle.



PPR9

Refractory pizza stone without handles. Squared shaped stone: L64xH2,3xP37,5 cm Suitable also for gas ovens, to be put on the griddle.



KITPBX

Height reduction feet (850mm), st/steel, for Sinfonia and Master cookers (845-856mm)



GT1P-2

Partially extractable telescopic guides (1 level) for ovens with metal frames. Length: 355.5 mm, extraction: 285 mm. Material: Stainless steel AISI 430 polished.



GTT

Totally extractable telescopic guides (1 level), suitable for traditional ovens. Made in stainless steel, they guarantee stability and facilitate the smooth extraction of the trays.



KITH95CPF9

Height extension kit with plinth, (950mm), three sides, black with feet, suitable for CPF9 Portofino and Sinfonia C9 cookers



GTP

Partially extractable telescopic guides (1 level), suitable for traditional ovens. Made in stainless steel, they guarantee stability and facilitate the smooth extraction of the trays.



TPKCPF9

Stainless steel teppanyaki plate, suitable for Portofino cookers



KIT600CPF9P

Cover strip for hob back side, suitable for 90 cm Portofino cookers with piro oven



KITPD

Height extension black feet (950 mm), black, suitable for Master, Sinfonia and Portofino 90cm (914-968mm); Height extension black feet (900 mm), black, suitable for Concerto cookers with 850mm height (880-935mm)



PALPZ

Pizza shovel with folding handle. Dimensions L31.5 x H32.5 cm. Easy and convenient to use and store. Perfect for serving pizza, bread and savory pastries in a safe and professional way.







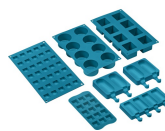

























SMOLD

Set of 7 silicone moulds for ice creams, ice lollies, pralines, ice cubes or to portion food. Usable from -60°C to +230°C



Symbols glossary (TT)

 <p>Heavy duty cast iron pan stands: for maximum stability and strength.</p>	 <p>Air cooling system: to ensure a safe surface temperatures.</p>
 <p>A+: Energy efficiency class A+ helps to save up to 10% energy compared to class A. Maximum performance with minimum consumption is guaranteed.</p>	 <p>Defrost by time: Manual defrost function. At the end of the set duration, the function stops.</p>
 <p>Defrost by weight: Automatic defrost function. You choose the type of food to defrost from the available categories (MEAT - FISH - BREAD - DESSERTS) After entering the weight of the food, the oven automatically defines the time required for proper defrosting.</p>	 <p>Quadruple glazed: Number of glazed doors.</p>
 <p>Ever Clean Enamel: Ever Clean enamel is applied electrostatically, corner to corner and edge to edge to prevent cracking or cracks over time. It is a particular pyrolytic enamel, resistant to acids which, in addition to being pleasantly bright, promotes greater cleaning of the oven walls, thanks to its lower porosity. It is baked at over 850 ° C and slowly polymerized at a scientifically determined rate to ensure uniform depth and strength Ever Clean enamel creates an impeccable finish both on the inside of the oven and on the trays, making the surfaces of the oven incredibly easy to maintain over time as it reduces the adhesion of fat during cooking</p>	 <p>Fingerprint proof stainless steel: Fingerprint proof stainless steel keeps stainless steel looking as good as new.</p>
 <p>Fan assisted base: the mix of fan and lower heating element alone allows to finish cooking foods already cooked on the surface but not internally more quickly. This system is recommended to finish cooking foods that are already well cooked on the surface, but not internally, which therefore require a moderate higher heat. Ideal for any type of food.</p>	 <p>Fan assisted: Intense and homogeneous traditional cooking, also suitable for complex recipes. The fan is active and the heat comes from below and from above at the same time. Ventilated cooking ensures a faster and more homogeneous result, leaving fragrant foods outside and moister inside. Ideal for baked pasta, biscuits, roasts and cobblers.</p>
 <p>Static: Traditional cooking suitable for the preparation of one dish at a time. The fan is not active and the heat comes from below and from above at the same time. Static cooking is slower and more delicate, ideal in order to get well cooked and dry dishes even inside. Ideal for cooking all types of roasts, fatty meats, bread, filled cakes.</p>	 <p>Base: the heat comes only from the bottom of the cavity. The fan is not active. Ideal for sweet and savory pies, cobblers and pizzas. Designed to complete cooking and make food more crunchy This symbol in gas ovens indicates the gas burner.</p>
 <p>Circulaire: it is the perfect function for cooking all types of dishes in a more delicate way. The heat comes from the back of the oven and is distributed quickly and evenly The fan is active. It is also ideal for cooking on multiple levels without mixing smells and flavors.</p>	 <p>ECO: low energy consumption cooking: this function is particularly suitable for cooking on a single shelf with low energy consumption. It is recommended for all types of food except those that can generate a lot of moisture (for example vegetables). To achieve maximum energy savings and reduce time, it is recommended to put the food in the oven without preheating the cooking compartment</p>

- | | |
|--|--|
|  <p>Grill: Very intense heat coming only from above from a double heating element. The fan is not active. Provides excellent grilling and gratinating results. Used at the end of cooking, it gives a uniform browning to dishes.</p> |  <p>Half grill: For rapid cooking and browning of foods. Best results can be obtained by using the top shelf for small items, the lower shelves for larger ones, such as chops or sausages. For half grill heat is generated only at the centre of the element, so is ideal for smaller quantities.</p> |
|  <p>Fan grill: very intense heat coming only from above from a double heating element The fan is active. It allows the optimal grilling of thickest meats. Ideal for large cuts of meat.</p> |  <p>Turbo: the heat comes from 3 directions: above, below and from the back of the oven The fan is active. It allows quick cooking, even on several shelves without mixing the aromas. Ideal for large volumes or foods that require intense cooking.</p> |
|  <p>All glass inner door: All glass inner door, a single flat surface which is simple to keep clean.</p> |  <p>The inner door glass: can be removed with a few quick movements for cleaning.</p> |
|  <p>Side lights: Two opposing side lights increase visibility inside the oven.</p> |  <p>PYROLYSIS - AUTOMATIC CLEANING FUNCTION: the oven heats up to a temperature approaching 500 ° C and chars grease and food residues into a fine ash that can be easily wiped off with a damp cloth. At such a high temperature, the door locks automatically for safety, while the temperature of the door remains controlled so it is safe to touch User adjustable function based on the level of dirt present in the oven.</p> |
|  <p>Pyrolytic: The Eco pyrolytic cleaning function can be selected when the oven has a lighter build up of dirt. This function has a maximum duration of 1.5 hours.</p> |  <p>Air at 40°C provides the perfect environment for proving yeast type dough mixes. Simply select the function and place dough in the cavity for allotted</p> |
|  <p>SABBATH: function that allows to cook food respecting Judaism's day of rest provisions.</p> |  <p>The oven cavity has 5 different cooking levels.</p> |
|  <p>Soft close: all models are equipped with advanced function of smooth closing of the door, which allows the device to close smoothly and quietly.</p> |  <p>Telescopic rails: allow you to pull out the dish and check it without having to remove it from the oven entirely.</p> |
|  <p>Electronic control: Allows you to maintain temperature inside the oven with the precision 2-3 ° C. This enables to cook meals that are very sensitive to temperature changes, such as cakes, souffles, puddings.</p> |  <p>Ultra rapid burners: Powerful ultra rapid burners offer up to 5kw of power.</p> |
|  <p>The capacity indicates the amount of usable space in the oven cavity in litres.</p> | |