

SO4102S3G

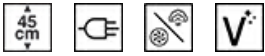

Category	45 cm
Product Family	Oven
Vitality system	Yes
Power supply	Electric
Heat source	ELECTRICITY
Cooking method	Combi Steam
Galileo platform	Steam100
Cleaning system	Vapor Clean
EAN code	8017709326876



Aesthetics

Aesthetic	Linea	Serigraphy colour	Black
Colour	Neptune grey	Serigraphy type	Symbols
Finishing	Matt	Door	Full glass
Design	Flat	Handle	Linea minimal
Material	Glass	Handle Colour	Satin metal and black
Glass Type	Clear	Logo	Silk screen

Controls



Display name	EvoScreen	Control setting	Full touch
Display technology	LCD		

Programme / Functions

No. of cooking functions 12

Traditional cooking functions

 Static	 Fan assisted	 Circulaire
 Turbo	 Eco	 Large grill
 Base	 Pizza	

Cooking functions with steam



Steam



Fan assisted



Circulaire



Sous Vide

Other Steam functions



Tank cleaning



Water outlet



Water input



Descaling

Other functions



Defrost by time



Leavening



Stone cooking



BBQ



Air-Fry



Sabbath

Cleaning functions



Vapor Clean

Options



Time-setting options

Delay start and automatic end cooking

Other options

Keep warm, Eco light, Tones, Brightness

Minute minder

Yes

Showroom demo option

Yes

Timer

1

Rapid pre-heating

Yes

Technical Features



Minimum Temperature

30 °C

Maximum temperature

250 °C

No. of shelves

2

Shelves type

Metal racks

N. of fans

1

No. of lights

1

Light type

Halogen

User-replaceable light

Yes

Light Power

40 W

Light when door is opened

Yes

Lower heating element power

1200 W

Grill element - power

1750 W

Circular heating element - Power

1400 W

Removable door

Yes

Full glass inner door

Yes

Removable inner door

Yes

Total no. of door glasses

3

Soft Close hinges

Yes

Soft Open

Yes

Safety Thermostat

Yes

Chimney

Variable

Cooling system

Tangential

Cooling duct

Single

Steam range

20 - 100%

Usable cavity space dimensions (HxWxD)

211x462x401 mm

Temperature control

Electronic

Cavity material

Ever clean Enamel

Water loading

Drawer, manual

Heating suspended when door is opened	Yes	Tank capacity	0,8 l
Door opening type	Standard opening		
Door	Temperate door		

Performance / Energy Label



Energy efficiency class	A++	Energy consumption in forced air convection	1.58 MJ
Net volume of the cavity	41 l	Energy consumption per cycle in fan-forced convection	0.44 kWh
Energy consumption per cycle in conventional mode	0.80 kWh	Number of cavities	1
Energy consumption in conventional mode	2.88 MJ	Energy efficiency index	61.1 %

Accessories Included

Rack with back stop (inox, concave)	1	St/steel tray (20mm)	1
Enamelled deep tray (50mm)	1	St/steel perforated deep tray (40mm)	1
Insert gird	1	Other	water loading kit

Electrical Connection

Voltage	220-240 V	Frequency (Hz)	50/60 Hz
Current	13 A	Power supply cable length	115 cm
Nominal power	3000 W		

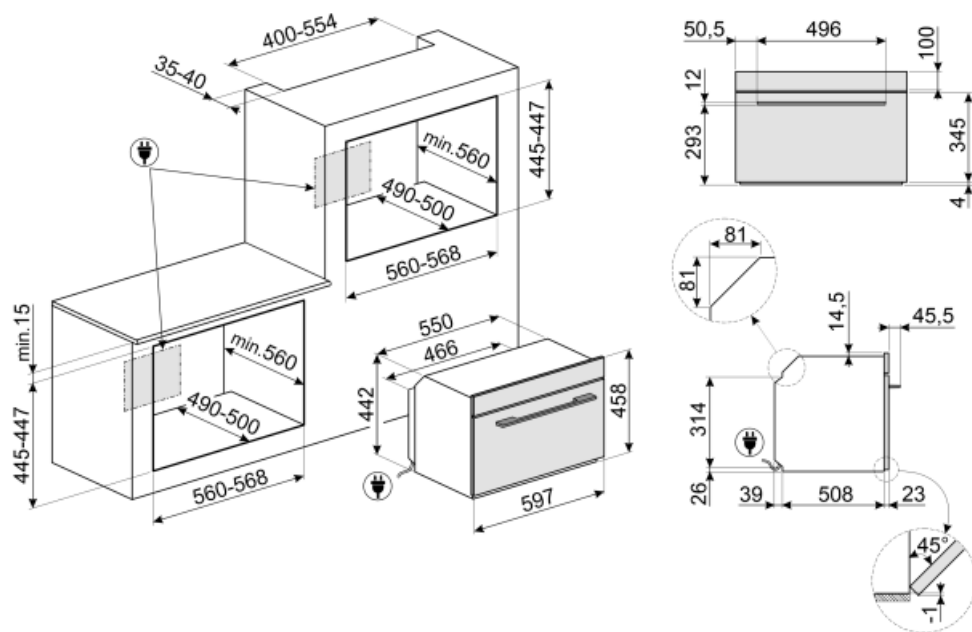

Not included accessories

AIRFRY

Air fryer rack AIRFRY . Ideal for recreating traditional frying in the oven, but with fewer calories and less fat. It allows you to cook quickly and simply dishes such as French fries, fried vegetables and fish, ensuring perfect browning and crispiness.



PR3845X

Antifingerprint stainless steel. Cover for furniture in column installation of more ovens



BX640PL

Stainless steel perforated tray. To cook many types of vegetables, fish, white meats, ravioli or other varieties of stuffed pasta, preserving all the vitamins and mineral salts for a richer, fuller and natural flavour



BN620-1

Enamelled tray suitable for 45cm and 60cm ovens. Depth 20 mm. Perfect for a wide range of savoury and sweet baking.



GT1P-2

Partially extractable telescopic guides (1 level) for ovens with metal frames. Length: 355.5 mm, extraction: 285 mm. Material: Stainless steel AISI 430 polished.



STONE

Rectangular refractory stone Ideal for cooking pizzas with the same results as a typical wood-fired oven. Can also be used for baking bread, focaccias and other recipes such as pies, flans or biscuits Dimensions:L42 x H1,8 x P37,5 cm.



GTP2

Partially extractable telescopic guides (1 level), suitable for traditional ovens. Made in stainless steel, they guarantee stability and facilitate the smooth extraction of the trays.



PRTX

Refractory pizza stone with handles. D=35cm Not suitable for microwave ovens. Suitable for gas ovens, to be put on the griddle.



ET50

Enamelled tray suitable for 45cm and 60cm ovens. Depth 50 mm. Perfect for cooking and roasting meat and fish in sauces. Also ideal for experimenting with lighter and crunchy side dishes



ET20

Enamelled tray suitable for 45cm and 60cm ovens. Depth 20 mm. Perfect for a wide range of savoury and sweet baking.



BBQ

Double sided plate BBQ. Suitable for recreating succulent and crispy dishes in the oven with the typical taste of grilled cooking. The ribbed side is particularly suitable for meats and cheeses. The smooth side for fish, seafood and vegetables.



PALPZ

Pizza shovel with folding handle. Dimensions L31.5 x H32.5 cm. Easy and convenient to use and store. Perfect for serving pizza, bread and savory pastries in a safe and professional way.





BN640

Enamelled tray suitable for 45cm and 60cm ovens. Depth 540 mm. Perfect for cooking and roasting meat and fish in sauces. Also ideal for experimenting with lighter and crunchy side dishes



GTTV2

Totally extractable telescopic guides (1 level), suitable for steam ovens. Made in stainless steel, they guarantee stability and facilitate the smooth extraction of the trays.

Symbols glossary (TT)

A++

A++: Energy efficiency class A++ helps to save up to 20% energy compared to class A. Maximum performance with minimum consumption is guaranteed.



Combi steam ovens: The steam cooking system allows to cook any type of food more gently and quickly. Variations in temperature and steam level allow you to achieve the desired gastronomic result. Steam cooking decrease the use of fat in favor of a healthier and more genuine cuisine, and also minimizes the loss of weight and volume of food during cooking. Steam cooking is perfect for cooking meats: in addition to making them very soft, it maintains their shine and makes them more succulent. Also recommended for cooking leavened doughs and bread-making: humidity in fact allows the dough to grow and develop during cooking before creating the external crust. The result is a lighter and more digestible dough, recognizable by the larger alveolation. It is also suitable for defrosting quickly, for heating foods without hardening or drying them and for naturally desalting salted foods.



Air cooling system: to ensure a safe surface temperatures.



Defrost by time: Manual defrost function. At the end of the set duration, the function stops.



Descaling function: Is essential to remove excess deposits of limestone in the tank and allow the proper operation of the product. The need to perform this operation is signaled by the product itself.



Triple glazed doors: Number of glazed doors.



Automatic lighting deactivation: For greater energy savings, the lighting turns off automatically after one minute from the start of cooking. The option can be disabled via the settings menu. In this case the light will remain on for the entire duration of cooking.



Electric



Ever Clean Enamel: Ever Clean enamel is applied electrostatically, corner to corner and edge to edge to prevent cracking or cracks over time. It is a particular pyrolytic enamel, resistant to acids which, in addition to being pleasantly bright, promotes greater cleaning of the oven walls, thanks to its lower porosity. It is baked at over 850 ° C and slowly polymerized at a scientifically determined rate to ensure uniform depth and strength. Ever Clean enamel creates an impeccable finish both on the inside of the oven and on the trays, making the surfaces of the oven incredibly easy to maintain over time as it reduces the adhesion of fat during cooking.



Fan assisted: Intense and homogeneous traditional cooking, also suitable for complex recipes. The fan is active and the heat comes from below and from above at the same time. Ventilated cooking ensures a faster and more homogeneous result, leaving fragrant foods outside and moister inside. Ideal for baked pasta, biscuits, roasts and cobblers.



Static: Traditional cooking suitable for the preparation of one dish at a time. The fan is not active and the heat comes from below and from above at the same time. Static cooking is slower and more delicate, ideal in order to get well cooked and dry dishes even inside. Ideal for cooking all types of roasts, fatty meats, bread, filled cakes.



Base: the heat comes only from the bottom of the cavity. The fan is not active. Ideal for sweet and savory pies, cobblers and pizzas. Designed to complete cooking and make food more crunchy. This symbol in gas ovens indicates the gas burner.



Circulaire: it is the perfect function for cooking all types of dishes in a more delicate way. The heat comes from the back of the oven and is distributed quickly and evenly. The fan is active. It is also ideal for cooking on multiple levels without mixing smells and flavors.



ECO: low energy consumption cooking: this function is particularly suitable for cooking on a single shelf with low energy consumption. It is recommended for all types of food except those that can generate a lot of moisture (for example vegetables). To achieve maximum energy savings and reduce time, it is recommended to put the food in the oven without preheating the cooking compartment.



Grill: Very intense heat coming only from above from a double heating element. The fan is not active. Provides excellent grilling and gratinating results. Used at the end of cooking, it gives a uniform browning to dishes.



Pizza function: Specific function for cooking pizza in a pan. It allows to obtain a pizza that is soft inside and crispy outside with the topping perfectly cooked, not dry and not burnt.



Sous Vide Cooking: Steam function for perfect cooking of sous vide dishes. Enhances the taste of dishes and keeps their appearance and nutrients unaltered. Vacuum cooking (Sous Vide) made with the help of a steam oven is also an incredible healthy and genuine type of cooking. The Sous Vide cooking technique allows heat to be efficiently transferred from the steam to the food, avoiding the loss of flavor due to oxidation and the evaporation of nutrients and moisture during cooking. Sous Vide cooking also allows better control over the cooking of food compared to traditional methods, ensuring uniform cooking results. It also allows cooking at a lower temperature than traditional cooking.



Steam cooking: it's a natural way of cooking for any kind of products, from vegetables to desserts, to preserve the nutritional and organoleptic properties of ingredients. Ideal for cooking without fat, to heat up food without drying. Steam is ideal for simultaneous cooking of meals that require different cooking times.



Fun assisted + Steam: intense and homogeneous cooking. The fan is active and the heat comes from below and from above at the same time. The addition of steam allows better preservation of the organoleptic properties of food and improves the internal cooking of foods, which are more crunchy and digestible. Ideal for roast veal, roast duck and for cooking whole fish.























Circulaire + Steam: The addition of steam to thermoventilated cooking allows better preservation of the organoleptic properties of food. The heat comes from the back of the oven and is distributed quickly and evenly. The fan is active. It is the perfect function for cooking all types of dishes in a more delicate way. It is also ideal for cooking on multiple levels without mixing smells and flavors. Ideal for preparing roasts, chicken and baked goods such as leavened cakes and bread.



FUN_STEAM_OTHER_WATER_IN_OUT_72dpi



Turbo: the heat comes from 3 directions: above, below and from the back of the oven. The fan is active. It allows quick cooking, even on several shelves without mixing the aromas. Ideal for large volumes or foods that require intense cooking.

- | | |
|--|--|
|  <p>Compact appliances with a height of 45 cm - perfect solution to meet the functional requirements of kitchen sets of small height. Available in several types and in different styles.</p> |  <p>All glass inner door: All glass inner door, a single flat surface which is simple to keep clean.</p> |
|  <p>The inner door glass: can be removed with a few quick movements for cleaning.</p> |  <p>KEEP_WARM_72dpi</p> |
|  <p>Side lights: Two opposing side lights increase visibility inside the oven.</p> |  <p>Air at 40°C provides the perfect environment for proving yeast type dough mixes. Simply select the function and place dough in the cavity for allotted</p> |
|  <p>Rapid preheating: cooking is preceded by the preheating phase which allows the cooking compartment to reach the set temperature. This option reduces the time by up to 50%.</p> |  <p>SABBATH: function that allows to cook food respecting Judaism's day of rest provisions.</p> |
|  <p>The oven cavity has 2 different cooking levels.</p> |  <p>Soft close: all models are equipped with advanced function of smooth closing of the door, which allows the device to close smoothly and quietly.</p> |
|  <p>To guarantee the optimal functioning of the appliance, it is suggested to carry out the tank cleaning roughly once every 2-3 months.</p> |  <p>Electronic control: Allows you to maintain temperature inside the oven with the precision 2-3 ° C. This enables to cook meals that are very sensitive to temperature changes, such as cakes, souffles, puddings.</p> |
|  <p>Touch controls: Easy to use touch controls allow the appliance to be programmed at the touch of a button.</p> |  <p>Vapor Clean: a simple cleaning function using steam to loosen deposits in the oven cavity.</p> |
|  <p>The capacity indicates the amount of usable space in the oven cavity in litres.</p> |  <p>The new EVOscreen display is enhanced with new, optimised colour graphics: 5 touch buttons control functions and parameters in an extremely simple way.</p> |
|  <p>Manual water loading system: It is possible to load the tank in less than 40 seconds. The loading is done manually thanks to a special funnel included.</p> |  <p>Dedicated cooking function for the double sided plate BBQ. Suitable for recreating succulent and crispy dishes in the oven with the typical taste of grilled cooking. The ribbed side is particularly suitable for meats and cheeses; the smooth side for fish, seafood and vegetables.</p> |
|  <p>Dedicated cooking function for the Air fryer rack AIRFRY . Ideal for recreating traditional frying in the oven, but with fewer calories and less fat. It allows you to cook quickly and simply dishes such as French fries, fried vegetables and fish, ensuring perfect browning and crispiness.</p> |  <p>Dedicated cooking function for the rectangular refractory stone PPR2 Dimensions Ideal for cooking pizzas with the same results as a typical wood-fired oven. Can also be used for baking bread, focaccias and other recipes such as pies, flans or biscuits</p> |