

SOP6102TB3



| | |
|------------------|-------------------|
| Category | 60cm |
| Product Family | Oven |
| Power supply | Electric |
| Heat source | ELECTRICITY |
| Cooking method | Thermo-ventilated |
| Galileo platform | Traditional pyro |
| Cleaning system | Pyrolitic |
| EAN code | 8017709327699 |



Aesthetics

| | | | |
|------------|--------|-------------------|---------------|
| Aesthetic | Linea | Serigraphy colour | Grey |
| Colour | Black | Serigraphy type | Symbols |
| Finishing | Glossy | Door | Full glass |
| Design | Flat | Handle | Linea minimal |
| Material | Glass | Handle Colour | Black |
| Glass Type | Clear | Logo | Silk screen |

Controls



| | | | |
|--------------------|-----------|-----------------|------------|
| Display name | EvoScreen | Control setting | Full touch |
| Display technology | LCD | | |

Programme / Functions

| | |
|--------------------------|----|
| No. of cooking functions | 10 |
|--------------------------|----|

Traditional cooking functions

| | | |
|--|--|---|
|  Static |  Fan assisted |  Circulaire |
|  Turbo |  Eco |  Large grill |
|  Fan grill (large) |  Base |  Circulaire + bottom |
|  Pizza | | |

Other functions

| | | |
|--|---|---|
|  Defrost by time |  Leavening |  Stone cooking |
|  BBQ |  Air-Fry |  Sabbath |

Cleaning functions

| |
|--|
|  Pirolysis |
|--|

Options



| | | | |
|-------------------------------------|---------------------------------------|-----------------------------|---|
| Time-setting options | Delay start and automatic end cooking | Other options | Keep warm, Eco light, Tones, Brightness |
| Minute minder | Yes | Showroom demo option | Yes |
| Timer | 1 | Rapid pre-heating | Yes |
| Controls Lock / Child Safety | Yes | | |

Technical Features



| | | | |
|------------------------------------|-------------|-----------------------------------|------------|
| Minimum Temperature | 30 °C | Removable door | Yes |
| Maximum temperature | 280 °C | Full glass inner door | Yes |
| No. of shelves | 5 | Removable inner door | Yes |
| Shelves type | Metal racks | Total no. of door glasses | 4 |
| N. of fans | 1 | Soft Close hinges | Yes |
| No. of lights | 2 | Soft Open | Yes |
| Light type | Halogen | Safety Thermostat | Yes |
| User-replaceable light | Yes | Chimney | Fixed |
| Light Power | 40 W | Cooling system | Tangential |
| Light when door is opened | Yes | Cooling duct | Double |
| Lower heating element power | 1200 W | Speed Reduction | Yes |
| Grill element - power | 1750 W | Cooling System | |
| | | Door Lock During Pirolysis | Yes |

| | | | |
|--|------------------|---|-------------------|
| Circular heating element - Power | 2000 W | Usable cavity space dimensions (HxWxD) | 353x470x401 mm |
| Heating suspended when door is opened | Yes | Temperature control | Electronic |
| Door opening type | Standard opening | Cavity material | Ever clean Enamel |
| Door | Cool | | |

Performance / Energy Label



| | | | |
|--|----------|--|----------|
| Energy efficiency class | A+ | Energy consumption in forced air convection | 2.45 MJ |
| Net volume of the cavity | 68 l | Energy consumption per cycle in fan-forced convection | 0.68 kWh |
| Energy consumption per cycle in conventional mode | 1.09 kWh | Number of cavities | 1 |
| Energy consumption in conventional mode | 3.92 MJ | Energy efficiency index | 81 % |

Accessories Included



| | | | |
|-----------------------------------|---|---|---|
| Rack with back stop | 1 | Insert gird | 1 |
| Enamelled tray (20mm) | 1 | Telescopic Guide rails, partial Extraction | 1 |
| Enamelled deep tray (50mm) | 1 | | |

Electrical Connection

| | | | |
|----------------------|-----------|----------------------------------|----------|
| Voltage | 220-240 V | Frequency (Hz) | 50/60 Hz |
| Current | 13 A | Power supply cable length | 115 cm |
| Nominal power | 3000 W | | |

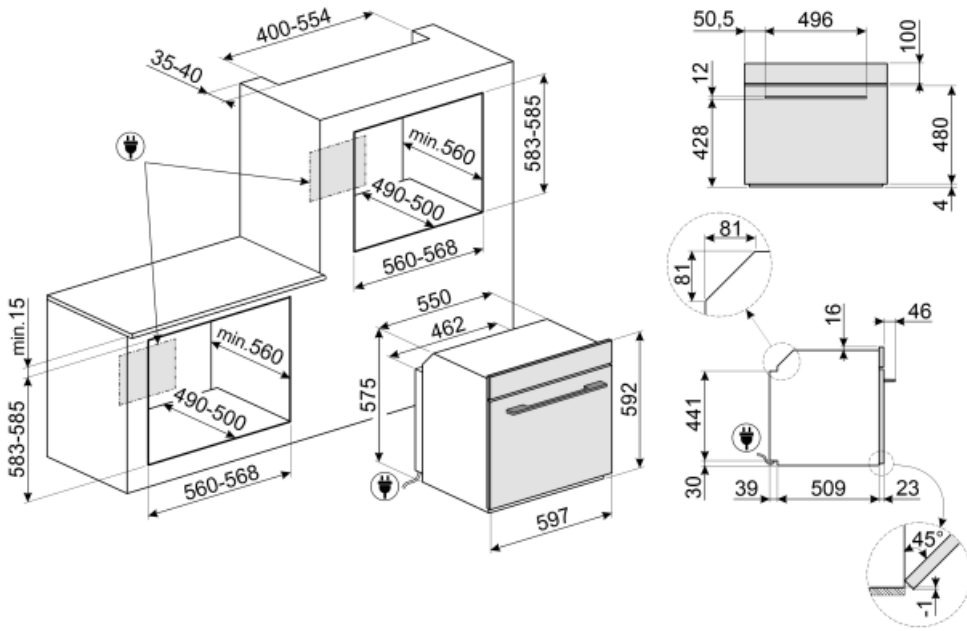

Not included accessories

AIRFRY

Air fryer rack AIRFRY . Ideal for recreating traditional frying in the oven, but with fewer calories and less fat. It allows you to cook quickly and simply dishes such as French fries, fried vegetables and fish, ensuring perfect browning and crispiness.



SFLK1

Child lock



ET50

Enamelled tray suitable for 45cm and 60cm ovens. Depth 50 mm. Perfect for cooking and roasting meat and fish in sauces. Also ideal for experimenting with lighter and crunchy side dishes



ET20

Enamelled tray suitable for 45cm and 60cm ovens. Depth 20 mm. Perfect for a wide range of savoury and sweet baking.



STONE

Rectangular refractory stone Ideal for cooking pizzas with the same results as a typical wood-fired oven. Can also be used for baking bread, focaccias and other recipes such as pies, flans or biscuits Dimensions:L42 x H1,8 x P37,5 cm.



GTP2

Partially extractable telescopic guides (1 level), suitable for traditional ovens. Made in stainless steel, they guarantee stability and facilitate the smooth extraction of the trays.



PR3845X

Antifingerprint stainless steel. Cover for furniture in column installation of more ovens



GTT2

Totally extractable telescopic guides (1 level), suitable for traditional ovens. Made in stainless steel, they guarantee stability and facilitate the smooth extraction of the trays.



BBQ

Double sided plate BBQ. Suitable for recreating succulent and crispy dishes in the oven with the typical taste of grilled cooking. The ribbed side is particularly suitable for meats and cheeses. The smooth side for fish, seafood and vegetables.





































PALPZ

Pizza shovel with folding handle. Dimensions L31.5 x H32.5 cm. Easy and convenient to use and store. Perfect for serving pizza, bread and savory pastries in a safe and professional way.



Symbols glossary (TT)

| | |
|---|---|
| <p> A+: Energy efficiency class A+ helps to save up to 10% energy compared to class A. Maximum performance with minimum consumption is guaranteed.</p> | <p> Child lock: some models are fitted with a device to lock the programme/cycle so it cannot be accidentally changed.</p> |
| <p> Air cooling system: to ensure a safe surface temperatures.</p> | <p> Defrost by time: Manual defrost function. At the end of the set duration, the function stops.</p> |
| <p> Quadruple glazed: Number of glazed doors.</p> | <p> Automatic lighting deactivation: For greater energy savings, the lighting turns off automatically after one minute from the start of cooking. The option can be disabled via the settings menu. In this case the light will remain on for the entire duration of cooking.</p> |
| <p> Electric</p> | <p> Ever Clean Enamel: Ever Clean enamel is applied electrostatically, corner to corner and edge to edge to prevent cracking or cracks over time. It is a particular pyrolytic enamel, resistant to acids which, in addition to being pleasantly bright, promotes greater cleaning of the oven walls, thanks to its lower porosity. It is baked at over 850 ° C and slowly polymerized at a scientifically determined rate to ensure uniform depth and strength. Ever Clean enamel creates an impeccable finish both on the inside of the oven and on the trays, making the surfaces of the oven incredibly easy to maintain over time as it reduces the adhesion of fat during cooking.</p> |
| <p> Fresh Touch: Most of Smeg ovens have a "cool door." Thanks to the combination of tangential cooling and internal heat-reflecting glasses, the temperature on the outer surface of the door is maintained below 50° C. In addition to providing safety, this system protects the sides of the furniture from overheating by the oven.</p> | <p> Fan assisted: Intense and homogeneous traditional cooking, also suitable for complex recipes. The fan is active and the heat comes from below and from above at the same time. Ventilated cooking ensures a faster and more homogeneous result, leaving fragrant foods outside and moister inside. Ideal for baked pasta, biscuits, roasts and cobblers.</p> |
| <p> Static: Traditional cooking suitable for the preparation of one dish at a time. The fan is not active and the heat comes from below and from above at the same time. Static cooking is slower and more delicate, ideal in order to get well cooked and dry dishes even inside. Ideal for cooking all types of roasts, fatty meats, bread, filled cakes.</p> | <p> Base: the heat comes only from the bottom of the cavity. The fan is not active. Ideal for sweet and savory pies, cobblers and pizzas. Designed to complete cooking and make food more crunchy. This symbol in gas ovens indicates the gas burner.</p> |
| <p> Circulaire with lower element: The addition of the lower element adds extra heat at the base for food which requires extra cooking.</p> | <p> Circulaire: it is the perfect function for cooking all types of dishes in a more delicate way. The heat comes from the back of the oven and is distributed quickly and evenly. The fan is active. It is also ideal for cooking on multiple levels without mixing smells and flavors.</p> |

- | | |
|--|--|
|  <p>ECO: low energy consumption cooking: this function is particularly suitable for cooking on a single shelf with low energy consumption. It is recommended for all types of food except those that can generate a lot of moisture (for example vegetables). To achieve maximum energy savings and reduce time, it is recommended to put the food in the oven without preheating the cooking compartment</p> |  <p>Grill: Very intense heat coming only from above from a double heating element. The fan is not active. Provides excellent grilling and gratinating results. Used at the end of cooking, it gives a uniform browning to dishes.</p> |
|  <p>Fan grill: very intense heat coming only from above from a double heating element The fan is active. It allows the optimal grilling of thickest meats. Ideal for large cuts of meat.</p> |  <p>Pizza function: Specific function for cooking pizza in a pan. It allows to obtain a pizza that is soft inside and crispy outside with the topping perfectly cooked, not dry and not burnt.</p> |
|  <p>Turbo: the heat comes from 3 directions: above, below and from the back of the oven The fan is active. It allows quick cooking, even on several shelves without mixing the aromas. Ideal for large volumes or foods that require intense cooking.</p> |  <p>All glass inner door: All glass inner door, a single flat surface which is simple to keep clean.</p> |
|  <p>The inner door glass: can be removed with a few quick movements for cleaning.</p> |  <p>KEEP_WARM_72dpi</p> |
|  <p>Side lights: Two opposing side lights increase visibility inside the oven.</p> |  <p>PYROLYSIS - AUTOMATIC CLEANING FUNCTION: the oven heats up to a temperature approaching 500 ° C and chars grease and food residues into a fine ash that can be easily wiped off with a damp cloth. At such a high temperature, the door locks automatically for safety, while the temperature of the door remains controlled so it is safe to touch User adjustable function based on the level of dirt present in the oven.</p> |
|  <p>Air at 40°C provides the perfect environment for proving yeast type dough mixes. Simply select the function and place dough in the cavity for allotted</p> |  <p>Rapid preheating: cooking is preceded by the preheating phase which allows the cooking compartment to reach the set temperature. This option reduces the time by up to 50%.</p> |
|  <p>SABBATH: function that allows to cook food respecting Judaism's day of rest provisions.</p> |  <p>The oven cavity has 5 different cooking levels.</p> |
|  <p>Soft close: all models are equipped with advanced function of smooth closing of the door, which allows the device to close smoothly and quietly.</p> |  <p>Telescopic rails: allow you to pull out the dish and check it without having to remove it from the oven entirely.</p> |
|  <p>Electronic control: Allows you to maintain temperature inside the oven with the precision 2-3 ° C. This enables to cook meals that are very sensitive to temperature changes, such as cakes, souffles, puddings.</p> |  <p>Touch controls: Easy to use touch controls allow the appliance to be programmed at the touch of a button.</p> |
|  <p>The capacity indicates the amount of usable space in the oven cavity in litres.</p> |  <p>The new EVOscreen display is enhanced with new, optimised colour graphics: 5 touch buttons control functions and parameters in an extremely simple way.</p> |



Dedicated cooking function for the double sided plate BBQ. Suitable for recreating succulent and crispy dishes in the oven with the typical taste of grilled cooking. The ribbed side is particularly suitable for meats and cheeses; the smooth side for fish, seafood and vegetables.



Dedicated cooking function for the rectangular refractory stone PPR2 Dimensions Ideal for cooking pizzas with the same results as a typical wood-fired oven. Can also be used for baking bread, focaccias and other recipes such as pies, flans or biscuits



Dedicated cooking function for the Air fryer rack AIRFRY . Ideal for recreating traditional frying in the oven, but with fewer calories and less fat. It allows you to cook quickly and simply dishes such as French fries, fried vegetables and fish, ensuring perfect browning and crispiness.