

# SIM1864DG



<b>Product Family</b>	Hob
<b>Built-in</b>	Ultra-low profile or Fully Flushed
<b>Dimensions</b>	80 cm
<b>Power supply</b>	Electric
<b>Type</b>	Induction
<b>EAN code</b>	8017709328023



## Aesthetics



<b>Aesthetics</b>	Linea
<b>Colour</b>	Neptune Grey
<b>Finishing</b>	Glass
<b>Material</b>	Glass
<b>Glass Type</b>	Eclipse ceramic
<b>Glass edge</b>	Straight edge
<b>Type of control setting</b>	Touch control back-lighted White
<b>Slider</b>	Yes
<b>Slider</b>	White
<b>Control knobs position</b>	Front
<b>Serigraphy colour</b>	Black

## Programs / Functions



<b>Total no. of cook zones</b>	6
<b>No. of induction cook zones</b>	6
<b>Time-setting options</b>	Automatic switch-off
<b>No. of cooking zones with booster</b>	6
<b>No. of Flexible zones</b>	3
<b>Main on/off switch</b>	Yes
<b>Power levels</b>	9
<b>Auto-vent 2.0</b>	Yes

## Options

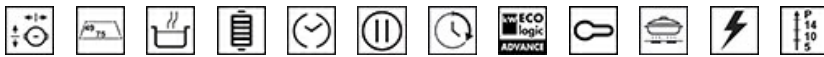

<b>Multizone Option</b>	Yes	<b>Residual time indicator</b>	Yes
<b>Flexible Zone Type</b>	MultiZone	<b>Limited Power Consumption Mode</b>	Yes advance
<b>Standard cut out</b>	490x750-780 mm	<b>Limited Power Consumption Mode in W</b>	2400 a 11100 - step 100 W
<b>Keep warm automatic function</b>	Yes	<b>Show Room Demo Option</b>	Yes
<b>Grill function</b>	Yes	<b>Control Lock / Child Safety</b>	Yes
<b>End cooking timer</b>	6	<b>Bridge option</b>	Yes
<b>Pause option</b>	Yes	<b>Quick start</b>	Yes
<b>Minute minder</b>	1	<b>Rapid level selection</b>	Yes
<b>End of cooking acoustic alarm</b>	Yes		

## Technical Features



Front left - Induction - Multizone - 2.10 kW - Booster 2.50 kW - Double booster 3 kW - 22.0x18.0 cm  
 Rear left - Induction - multizone - 2.10 kW - Booster 2.50 kW - Double booster 3 kW - 22.0x18.0 cm  
 Front centre - Induction - Multizone - 2.10 kW - Booster 2.50 kW - Double booster 3 kW - 22.0x18.0 cm  
 Rear centre - Induction - multizone - 2.10 kW - Booster 2.50 kW - Double booster 3 kW - 22.0x18.0 cm  
 Front right - Induction - Multizone - 2.10 kW - Booster 2.50 kW - Double booster 3 kW - 22.0x18.0 cm  
 Rear right - Induction - multizone - 2.10 kW - Booster 2.50 kW - Double booster 3 kW - 22.0x18.0 cm  
 38.5x23.0 cm  
 38.5x23.0 cm  
 38.5x23.0 cm

<b>Automatic setting according to pan dimension</b>	Yes	<b>Automatic switch off when overflow</b>	Yes
<b>Automatic pan detection</b>	Yes, min 9 cm	<b>Residual heat indicator</b>	Yes
<b>Permanent Automatic Pot Detection with indication of the relative control</b>	Yes	<b>Protection against accidental start up</b>	Yes
<b>Automatic switch off when overheat</b>	Yes		

## Electrical Connection

<b>Nominal power (W)</b>	7400 W	<b>Type of electric cable</b>	Double universal
<b>Current</b>	33 A	<b>Frequency (Hz)</b>	50/60 Hz
<b>Voltage (V)</b>	220-240 V	<b>Power supply cable length</b>	120 cm
<b>Voltage 2 (V)</b>	380-415 V	<b>Terminal Box</b>	5 poles

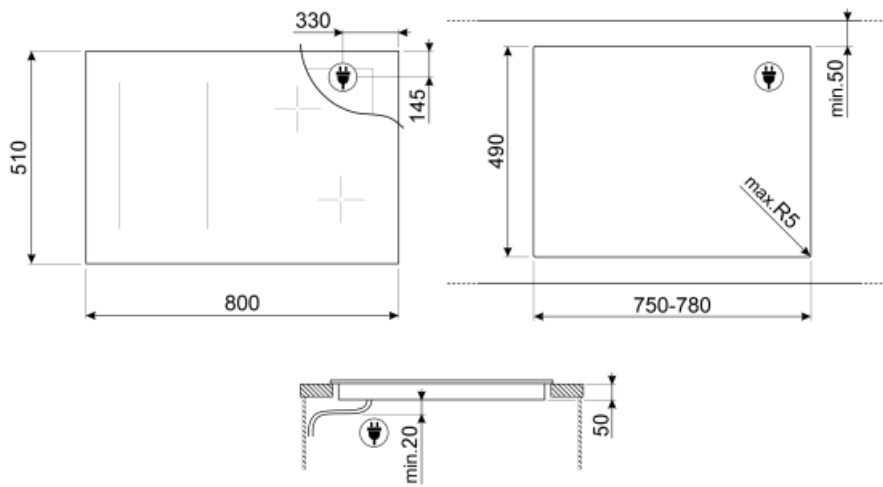

## Not included accessories

---



### GRILLPLATE

Universal griddle for induction, gas, ceramic and electric hobs. Non-stick surface ideal for cooking meat, cheese and vegetables. Dimensions: 410 x 240 mm.



### TPK

Stainless steel grill plate to cook Teppanyaki dishes



### SCRP























Induction and ceramic hobs and teppanyaki scraper



### TPKPLATE

Universal plate for induction, gas, ceramic and electric hobs. Non-stick surface ideal for cooking fish, eggs and vegetables. Dimensions: 410 X 240 mm.

## Symbols glossary

	...		...
	Power booster: option allows the zone to work at full power when very intense cooking is necessary.		Child lock: some models are fitted with a device to lock the programme/cycle so it cannot be accidentally changed.
	The slider control panel allows you to adjust the power simply by passing your finger across the touch device.		Evolution Slider totally Back-lighted ghost effect
	Keep warm function: Keep warm function keeps the cooked food heated. In this mode the heating zone operates at a minimum capacity for 120 minutes and then turns off automatically.		Overheat protection: The safety system that automatically turns off the hob in case of overheating of the control unit.
	Induction: The work of these hobs is based on the principle of electromagnetic induction. The heat is generated directly in the bottom of the pan during its contact with the hob.		Multizone: allows several pans to be used at once, large or small, offering freedom of placement and greater flexibility
	Overfill protection: The special overfill protection shuts down the stove in the presence of overflow of liquids.		PAUSE_72dpi
	Quick selection, with one touch cooking begins at the highest level, then automatically reduces after time. Ideal for dishes that require quick boiling and then continued cooking without constant control (eg beef broth).		Quick Start function: the chosen temperature is reached faster. The heating element works at maximum power until the right temperature is reached.
	Indication of residual heat: After the glass ceramic hob is switched off the residual heat indicator shows which of the heating zones still remains hot. When the temperature drops below 60 ° C, the indicator goes out.		...
	Perfect fit in a 80 cm cabinet		Darkness becomes light
	Time elapsed: shows how long the cooking zone has been in use.		Timer: All ceramic hobs have a timer which automatically ends cooking after a preset time.
	TWIN_ZONE_72dpi		...
	...		