

# SF6100VB3



Category	60cm
Product Family	Oven
Power supply	Electric
Heat source	Electric
Cooking method	Fan assisted
EAN code	8017709327965



## Aesthetics

Aesthetics	Linea	Serigraphy colour	Grey
Colour	Black	Serigraphy type	Symbols
Finishing	Gloss	Door	Full glass
Design	Flat	Handle	Linea minimal
Material	Glass	Handle Colour	Black
Glass Type	Clear1	Logo	Silk screen







## Controls



Display name	DigiScreen	No. of controls	2
Display technology	LED	Control knobs	Linea
Control setting	Knobs & touch buttons	Controls colour	Matt black

## Programs / Functions

No. of cooking functions 6  
Traditional cooking functions

 Static	 Fan assisted	 ECO
 Large grill	 Fan grill (large)	 Fan assisted base

## Options



<b>Time-setting options</b>	Delay start and automatic end cooking	<b>Timer</b>	1
<b>Minute minder</b>	Yes	<b>Rapid pre-heating</b>	Yes

## Technical Features



<b>Minimum Temperature</b>	50 °C	<b>Door opening type</b>	Standard opening
<b>Maximum temperature</b>	250 °C	<b>Door</b>	Temperate door
<b>Shelf positions</b>	5	<b>Removable door</b>	Yes
<b>Shelves type</b>	Metal racks	<b>Full glass inner door</b>	Yes
<b>No. of lights</b>	1	<b>Removable inner door</b>	Yes
<b>Light type</b>	Halogen	<b>Total no. of door glasses</b>	3
<b>User-replaceable light</b>	Yes	<b>Safety Thermostat</b>	Yes
<b>Light power</b>	40 W	<b>Chimney</b>	Fixed
<b>Light when door is opened</b>	Yes	<b>Cooling system</b>	Tangential
<b>Lower heating element power</b>	1200 W	<b>Cooling duct</b>	Single
<b>Upper heating element - Power</b>	1000 W	<b>Speed Reduction Cooling System</b>	Yes
<b>Grill element - power</b>	1700 W	<b>Usable cavity space dimensions (HxWxD)</b>	360x460x425 mm
<b>Large grill - Power</b>	2700 W	<b>Temperature control</b>	Electronic
<b>Heating suspended when door is opened</b>	Yes	<b>Cavity material</b>	Easy clean enamel

## Performance / Energy Label



<b>Energy efficiency class</b>	A	<b>Energy consumption in forced air convection</b>	2.88 MJ
<b>Net volume of the cavity</b>	70 litres	<b>Energy consumption per cycle in fan-forced convection</b>	0.80 KWh
<b>Energy consumption per cycle in conventional mode</b>	1.15 KWh	<b>Number of cavities</b>	1
<b>Energy consumption in conventional mode</b>	4.14 MJ	<b>Energy efficiency index</b>	95.2 %

## Accessories Included

<b>Chrome shelf with back and side stop</b>	1	<b>Extra deep enamelled tray (40mm)</b>	1
---	---	---	---

## Electrical Connection

<b>Voltage</b>	220-240 V	<b>Frequency (Hz)</b>	50/60 Hz
<b>Current</b>	13 A		

Nominal power (W)

3000 W

Power supply cable  
length

115 cm

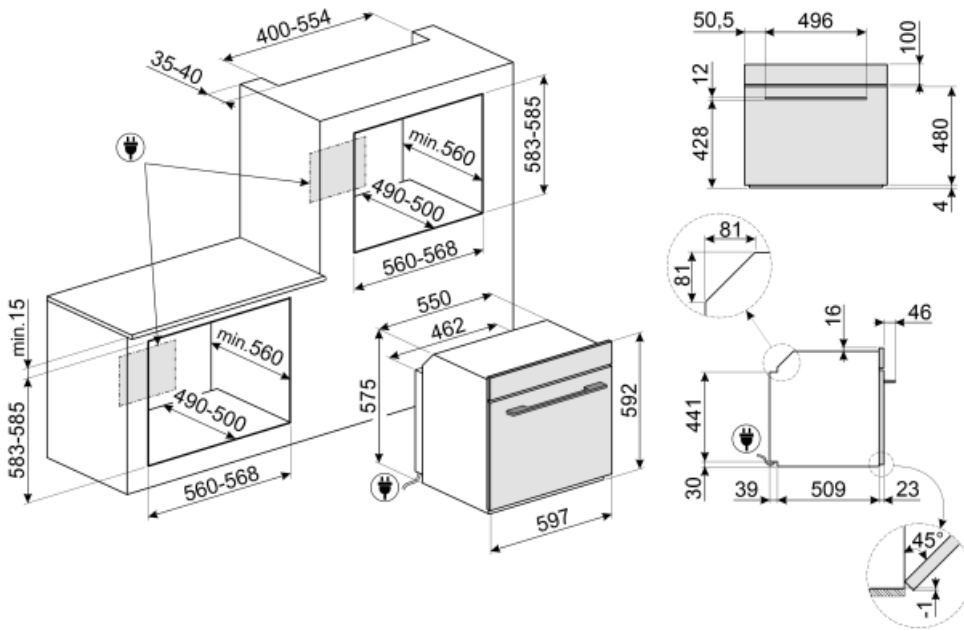

## Not included accessories

### GTP

\*\*Partially extractable telescopic guides (1 level)\*\* Extraction: 300 mm Material: Stainless steel AISI 430 polished



### PRTX

Refractory pizza stone with handles. D=35cm Not suitable for microwave ovens. Suitable for gas ovens, to be put on the griddle.



### GT1P-2

Partially extractable telescopic guides (1 level) for ovens with metal frames. Length: 355.5 mm, extraction: 285 mm. Material: Stainless steel AISI 430 polished.



### GTT

\*\*Totally extractable telescopic guides (1 level)\*\* Extraction: 433 mm Material: Stainless steel AISI 430 polished



### PR3845X

Antifingerprint stainless steel. Cover for furniture in column installation of more ovens



### BN620-1

Enamelled tray, 20mm deep



### PALPZ

Pizza shovel with fold away handle width: 315mm length : 325mm





















### BN640

Enamelled tray, 40mm deep



## Symbols glossary

 <p>A: Product drying performance, measured from A+++ to D / G depending on the product family</p>	 <p>Air cooling system: to ensure a safe surface temperatures.</p>
 <p>Triple glazed doors: Number of glazed doors.</p>	 <p>Electric</p>
 <p>Enamel interior: The enamel interior of all Smeg ovens have a special antacid lining which helps keep the interior clean by reducing the amount of cooking grease adhering to it.</p>	 <p>Circogas: In gas ovens the fan distributes the heat quickly and evenly throughout the oven cavity, avoiding flavour transfer when cooking a number of different dishes at the same time. In electric ovens this combination completes cooking more quickly of foods that are ready on the surface, but that require more cooking inside, without further browning.</p>
 <p>Fan with upper and lower elements: The elements combined with the fan aim to provide more uniform heat, a similar method to conventional cooking, so pre-heat is required. Most suitable for items requiring slow cooking methods.</p>	 <p>Upper and lower element only: a traditional cooking method best suited for single items located in the centre of the oven. the top pf the oven will always be hottest. Ideal for roast, fruit cakes, bread etc.</p>
 <p>ECO: The combination of the grill, fan and lower element is particularly suitable for cooking small quantities of food.</p>	 <p>Grill element: Using of grill gives excellent results when cooking meat of medium and small portions, especially when combined with a rotisserie (where possible). Also ideal for cooking sausages and bacon.</p>
 <p>Fan with grill element: The fan reduces the fierce heat from the grill, providing an excellent method of grilling various foods, chops, steaks, sausages etc. giving even browning and heat distribution, without drying out the food. The top two levels recommended for use, and the lower part of the oven can be used to keep items warm at the same time, an excellent facility when cooking a grilled breakfast. Half grill (centre portion only) is ideal for small quantities of food.</p>	 <p>All glass inner door: All glass inner door, a single flat surface which is simple to keep clean.</p>
 <p>The inner door glass: can be removed with a few quick movements for cleaning.</p>	 <p>Side lights: Two opposing side lights increase visibility inside the oven.</p>
 <p>Rapid preheat: The rapid preheat function can be used to reach the selected temperature in just a few minutes.</p>	 <p>The oven cavity has 5 different cooking levels.</p>
 <p>Electronic control: Allows you to maintain temperature inside the oven with the precision 2-3 ° C. This enables to cook meals that are very sensitive to temperature changes, such as cakes, souffles, puddings.</p>	 <p>The capacity indicates the amount of usable space in the oven cavity in litres.</p>
 <p>...</p>	