

FMI625CN

Usable volume

25 l



Product Family

Microwave

Category

Built-in

Installation

Fully Built-in

Power supply

Electric

Cooking Method

Combi Microwave

Control

Electronic



Programme / Functions

No. of functions

6

Circulaire + fan + grill



Full grill



Defrost by time



Microwave



Microwave + grill



Microwave + circulaire + fan



Automatic programmes

10

Other Microwave functions

Multi-session cooking

Controls



Display / Clock

1 a LED

Opening

Electrical button

Type of control setting

Touch control

Options



Timer

Electronic

Controls Lock / Child

Yes

Time-setting options

End cooking

Safety

Quick start option

Yes

End of cooking acoustic alarm Yes

Technical Features



Cavity material	Stainless steel	Circulaire heating element - Power	2500 W
No. of shelves/ levels	2	Door opening	Side-opening
Shelves type	Rack	Total no. of door glasses	1
No. of lights	1	Safety Thermostat	Yes
Light type	Led	Cooling system	Tangential
Turntable	Yes	Microwave screen protection	Yes
Turntable dimensions	31.5 cm	Microwave stops when door is opened	Yes
Light when door is opened	Yes	Usable cavity space dimensions (HxWxD)	206x368x328 mm
Grill type	Quartz	Microwave effective power	900 W
Grill - power	1100 W		

Accessories Included







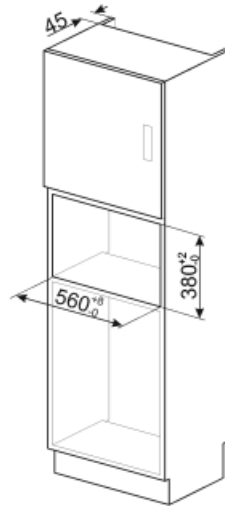
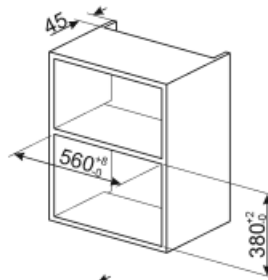
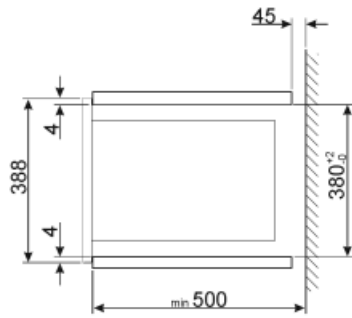
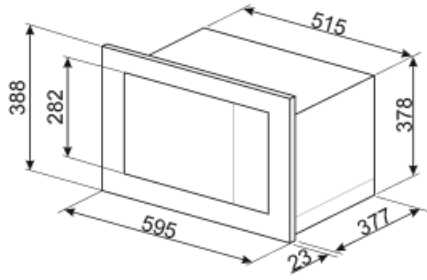





Grid	1	Frame	Yes
------	---	-------	-----

Electrical Connection

Nominal power	2500 W	Frequency (Hz)	50 Hz
Current	11 A	Power supply cable length	150 cm
Voltage (V)	230 V		



Symbols glossary (TT)

 <p>Child lock: some models are fitted with a device to lock the programme/cycle so it cannot be accidentally changed.</p>	 <p>Combination microwave: This oven allows to combine two different ways of cooking (Traditional with microwaves). Combined ovens increase cooking opportunities, while providing maximum flexibility of household appliances.</p>
 <p>Microwave energy shortens cooking times dramatically and produces energy savings.</p>	 <p>Defrost by time: Manual defrost function. At the end of the set duration, the function stops.</p>
 <p>Circulaire + grill: Circulaire with upper element or grill: Similar to fan with upper element with the added cooking speed of circulaire, ideal for dishes with a crispy topping. When used with the grill the food will brown more quickly.</p>	 <p>Grill: Very intense heat coming only from above from a double heating element. The fan is not active. Provides excellent grilling and gratinating results. Used at the end of cooking, it gives a uniform browning to dishes.</p>
 <p>Microwave: Penetrating straight into the food, microwaves cook very quickly and with considerable energy savings. Suitable for cooking without fat, they are also able to thaw and heat food without altering its original appearance and aroma. The microwave function can also be combined with conventional functions with all the resulting advantages. Ideal for all types of food.</p>	 <p>Cooking with the simultaneous use of the heating element in combination with fan and microwave supply.</p>
 <p>Microwave + grill element: The use of the grill results in a perfect browning of the surface of the food. The action of microwaves allows instead of cooking in a short time the internal part of the food.</p>	 <p>Side lights: Two opposing side lights increase visibility inside the oven.</p>
 <p>The oven cavity has 2 different cooking levels.</p>	 <p>Touch controls: Easy to use touch controls allow the appliance to be programmed at the touch of a button.</p>
 <p>The capacity indicates the amount of usable space in the oven cavity in litres.</p>	