

RI96LSI



Product Family	Refrigerator
Installation	Built-in
Category	Bottom Mount
Built-in niche	>200
Reference width	Higher than 80
Reference height	Higher than 200
Sistema Total No - Frost	Total
Cooling type	Fan assisted refrigerator, no-frost freezer
Defrost	Automatic
Hinge type	Door on door
Hinge position	Left
EAN code	8017709205096



Aesthetics



Aesthetic	Universale	Side colour	Silver
Material	Metal sheet	Logo	Silk screen
Handle	Not included	Display	LCD Touch
Side material	Steel	Water Filter	Internal

Refrigerator compartment features



No. of adjustable shelves	3	Type of crisper/vegetable drawers cover	Glass
Number of fruit and vegetables drawers	1	Life Plus zone-0°C	Yes
Type of adjustable shelves	Glass	Internal light in fridge	Yes
Type of crisper/vegetable drawers cover	On sliding rails	Type of internal light (fridge)	LED
Crisper Cover	Yes		

Refrigerator Inner Door

Number of adjustable door shelves	2	No. of bottle shelves	1
Adjustable door shelves with wire support	Yes	Bottle shelves with wire support	Yes

Other Refrigerator features



MultiFlow Yes

Freezer compartment features

Number of drawers	2	Type of internal light (freezer)	LED
Internal light in freezer	Yes		

Other Freezer features

Ice maker	Automatic	Ice tray shelf	Yes
-----------	-----------	----------------	-----

Other technical features



Functions display	Holiday, Fast freezing, Fast cooling, MultiZone, Control lock, Temperature alarm, Cooling timer, Demo Mode, Sabbath
MultiZone	Yes
Water network connection	Yes
Temperature alarm lamp	Yes
Door open alarm	Yes
Temperature Alarm	Acoustic and visual
Type of temperature control	Electronic
No. of compressors	2
Refrigerant gas type	R600a
Type of compressor	Inverter
Refrigerant Quantity (gr)	48 g
Foam agent	Cyclopentane

Performance / Energy Label NEW 2019



Annual energy consumption	342 kWh/a	Sum of the volumes of the chill compartment(s) and the unfrozen compartment(s)	425 l
Energy efficiency class	F	Airborne acoustical noise emissions	41 dB(A) re 1pW
Airborne acoustical noise emission class	C	Temperature Rise Time	10 h
Total net volume	131 l	Climate class	SN, N, ST, T
Sum of the volumes of the frozen compartment(s)	131 l	EEl	116 %

Electrical Connection

Plug	(F;E) Schuko	Voltage (V)	220-240 V
Electrical connection rating	240 W	Frequency (Hz)	50 Hz
Current	1,5 A	Power supply cable length	250 cm

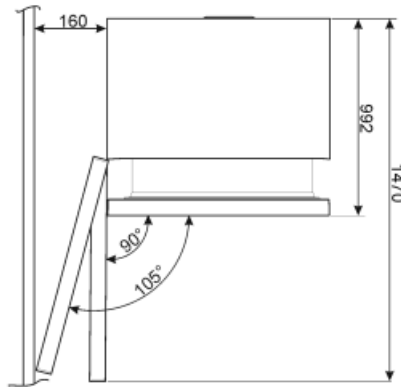
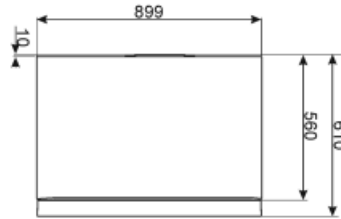
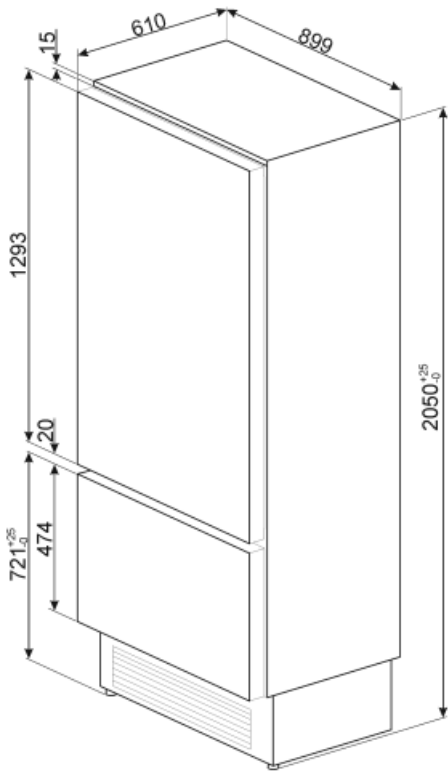















Not included accessories

REFLKB1

Connecting Kit

Symbols glossary (TT)

 <p>4 stars freezing compartment for better food preservation.</p>	 <p>A+: Energy efficiency class A+ helps to save up to 10% energy compared to class A. Maximum performance with minimum consumption is guaranteed.</p>
 <p>The automatic defrost system works by automatically defrosting at regular intervals eliminating the need to defrost altogether.</p>	 <p>Child lock: some models are fitted with a device to lock the programme/cycle so it cannot be accidentally changed.</p>
 <p>LCD display: to optimize performance and simplify the use of the appliance.</p>	 <p>Fast freezing: The fast freezing function brings the temperature of the compartment down when activated a few hours prior to usage.</p>
 <p>Power saving mode: The power saving mode allows you to disable the refrigerator and keep the freezer working.</p>	 <p>LED interior lighting: is a more energy efficient and long lasting way of illuminating the interior of the appliance.</p>
 <p>Life Plus 0°C: The temperature in the Lifeplus compartments is kept at 0°C, which preserves fresh meat and fish longer.</p>	 <p>Smeg's evolution towards more intelligent and eco-friendly models has led to the choice of Inverter technology, which significantly reduces consumption.</p>
 <p>Air plus: keeps food fresher for longer.</p>	 <p>Multizone: Multizone compartment can be used as a refrigerator or a freezer compartment. Depending on your needs and eating habits, you can select settings, program the temperature using.</p>
 <p>No Frost: The No Frost and Frost free systems prevent ice from forming so that no defrosting is required.</p>	 <p>Energy efficiency class F</p>