

U8C082DF



Product Family	Refrigerator
Installation	Built-in
Category	Under counter
Built-in niche	82 - 87
Reference width	Until 60
Reference height	Until 100
Cooling type	Static
Defrost	Manual
Hinge type	Door on door
Hinge position	Right
Reversible door	Yes
EAN code	8017709295493



Aesthetics



Aesthetic	Universale	Logo	Silk screen
Colour	White	Door shelves profile color	Silver
Design	Flat	Drawers profile color	Silver
Material	Metal sheet	Color of glass shelf profile	Chrome
Side material	Steel	Display	LED
Side colour	White	Display position	Interno (cella frigo)

Refrigerator compartment features



No. of adjustable shelves	2	Crisper Cover	Yes
Number of fruit and vegetables drawers	1	Type of crisper/vegetable drawers cover	Glass
Type of adjustable shelves	Glass	Internal light in fridge	Yes
Type of crisper/vegetable drawers cover	Standard	Type of internal light (fridge)	LED

Refrigerator Inner Door

No. of door shelves with transparent cover	1	No. of bottle shelves	1
---	---	------------------------------	---

Adjustable door shelves with wire support Yes

Bottle shelves with wire support Yes

Other Refrigerator features

Accessories Kit listeria, Egg tray

Freezer compartment features

Internal freezer compartment Yes

Other technical features

Type of temperature control	Electronic
No. of compressors	1
Refrigerant gas type	R600a
Refrigerant Quantity (gr)	32 g
Max weight door panel (fridge)	32 kg
Foam agent	Cyclopentane

Performance / Energy Label NEW 2019





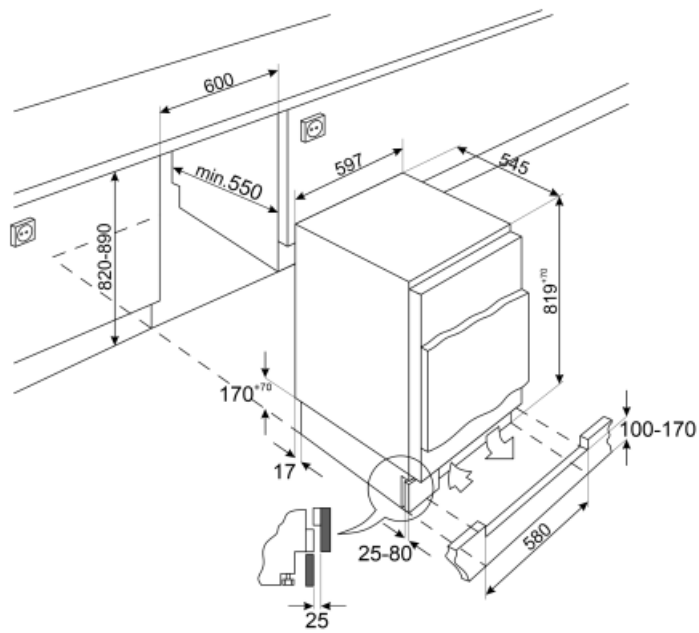

			
Annual energy consumption	185 kWh/a	Airborne acoustical noise emissions	38 dB(A) re 1pW
Energy efficiency class	F	Temperature Rise Time	8.20 h
Airborne acoustical noise emission class	C	4 star - Freezing capacity	2.6 Kg/24h
Total net volume	111 l	Climate class	SN, N, ST
Sum of the volumes of the frozen compartment(s)	16 l	EI	124 %
Sum of the volumes of the chill compartment(s) and the unfrozen compartment(s)	94 l		

Electrical Connection

Plug	(F;E) Schuko	Voltage (V)	230-240 V
Electrical connection rating	110 W	Frequency (Hz)	50 Hz
Current	0.9 A	Power supply cable length	240 cm



Symbols glossary (TT)

- | | | | |
|--|---|---|--|
|  | 4 stars freezing compartment for better food preservation. |  | A+: Energy efficiency class A+ helps to save up to 10% energy compared to class A. Maximum performance with minimum consumption is guaranteed. |
|  | LED display: to show programmes, functions and options selected and the time to the end of the cycle. |  | LED interior lighting: is a more energy efficient and long lasting way of illuminating the interior of the appliance. |
|  | Built-in niche |  | Energy efficiency class F |