

KV694R



Product family	Hood
Hood Type	Decorative wall hood
Design	Angled
Extraction	Extraction
Electronic control	Yes
Perimeter extraction	Yes
Material	Glass
EAN code	8017709305789
Hood width	90 cm







Aesthetics

Aesthetic	Dolce Stil Novo	Glass Type	Black
Colour	Black	Serigraphy colour	Grey
Finishing	Copper	Logo	Silk screen

Controls

Control setting	Touch control back-lighted White	Led color	White
-----------------	-------------------------------------	-----------	-------

Programme / Functions

No. of speeds	3
Intensive speed	
24h air filter function	
Time-setting options	
Auto-vent 2.0	

Technical Features

     	No. of lights	2	Anti-grease filters	Stainless steel
	Light type	LED	Charcoal filters included	Yes
	Light Power	2.1 W		

Dimmer mode	Yes	Filter replacement indicator	Yes
Light color temperature range	2700° - 4000° °K	Vent outlet	150 mm
Free outlet maximum capacity	820 m³/h	Minimum distance from GAS hob	650 mm
Motor power	275 W	Minimum distance from ELECTRIC hob	450 mm
No. of filters	2	Non return valve	Yes

	Extraction rate IEC 61591 [m³/h]	Noise level IEC 60704-2-13 [dB(A)]
Speed 1	265	47
Speed 2	391	55
Speed 3	621	66
Intensive speed	777	70

Performance / Energy Label

A*

Annual Efficiency Consumption (AEChood)	42 kWh/a	Airborne acoustical A-weighted sound Power Emission at maximum speed (SPEmax)	67 dB(A)
Energy efficiency class (EEC)	A+	Airbourne acoustical A-weighted sound power emission at boost speed (SPEboost)	70 dB(A)
Fluid Dynamic Efficiency (FDE)	35.6	Power Consumption in Off mode (Po)	0.49 W
Fluid Dynamic Efficiency class (FDEC)	A	Power consumption in stand-by mode (Ps)	0.99 W
Lighting Efficiency (LE)	35.5 lux/W	Time increase factor (F)	0.7
Lighting Efficiency Class (LEC)	A	Energy Efficiency Index	41.3
Grease Filtering Efficiency (GFE)	64.2 %	Measured air flow rate at best efficiency point (Qbep)	400 m³/h
Grease Filtering Efficiency Class (GFEC)	E	Measured air pressure at best efficiency point (Pbep)	485 Pa
Air flow at minumum speed (Qmin)	265 m³/h	Measured electric power input at best efficiency point (Wbep)	151 W
Air flow at maximum speed (Qmax)	621 m³/h	Nominal Power consumption of the light system (WL)	4 W
Air flow at boost speed (Qboost)	777 m³/h	Average illumination of the light on the cooking surface (Emiddle)	142 lux
Airbourne acouistical A-weighted sound Power Emission at minimum speed (SPEmin)	47 dB(A)	Sound power level at highest setting (Lwa)	67 dB(A)

Electrical Connection

Electrical connection rating 279 W
Voltage 220-240 V

Frequency (Hz) 50-60 Hz
Power supply cable length 1500 mm

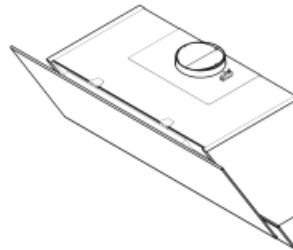
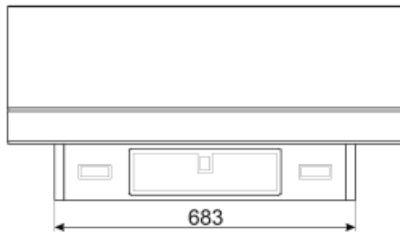
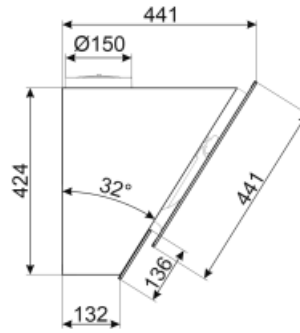
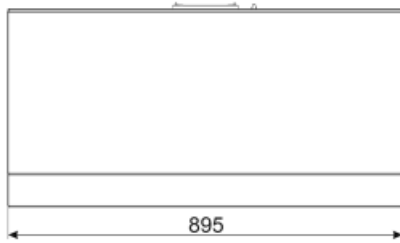

Not included accessories



KITFCKV6

Kit 3 pcs of charcoal filter for vertical hood KV6* series. Dishwasher-safe. Size 320x80mm and 2 pcs 210x280 mm



KITALLFC

Universal Charcoal filter Stainless Steel AISI 304 The filter can be washed in dishwasher 50 °C (water and suitable detergent) and to dry it put in the oven 180°C 25 minutes



KITCMNKVX













Chimney Extension in Stainless Steel for hood KV*series 300 mm*200 mm + 500/850 mm



KITCMNKVMB

Chimney Extension in Stainless Steel for hood KV*series 300 mm*200 mm + 500/850 mm

Symbols glossary (TT)

- | | | | |
|---|---|--|--|
|  | 24h: When selected this function refreshes the air for c. 10 minutes every hour over a 24 hour period, at minimum speed and an imperceptible noise level. |  | Filters: Model has filters to help remove grease from the steam emanating from the pans during cooking. |
|  | Switch off automatically: A special setting, to run after the end of cooking for a pre-set time and then switch off automatically. |  | Charcoal filters: Extracting through charcoal filters or directly to the exterior lessens strong cooking odours considerably. |
|  | Connection between hob and hood |  | A+: Energy efficiency class A+ helps to save up to 10% energy compared to class A. Maximum performance with minimum consumption is guaranteed. |
|  | Warning light(s): to advise when filters need changing. |  | Lights: All cooker hoods feature lights to illuminate the cooking area or add to the ambience of the kitchen. |
|  | Perimeter extraction panels: very efficient and aid noise reduction. |  | Intensive/turbo setting: when extra fast extraction is required. |
|  | Dimmering Lights |  | Tunable white from warm to cold |