

TR93IGR2

Cooker size	90x60 cm
N. of cavities with energy label	2
Cavity heat source	ELECTRICITY
Hob type	Induction
Type of main oven	Thermo-ventilated
Type of second oven	Thermo-ventilated
Cleaning system main oven	Vapor Clean
EAN code	8017709312398
Energy efficiency class	A
Energy efficiency class, second cavity	B



Aesthetics

Aesthetic	Victoria	Display	electronic 5 buttons
Colour	Slate Grey	Colour of buttons	Black
Finishing	Glossy	No. of controls	9
Design	Victoria	Serigraphy colour	Black
Door	With frame	Handle	Smeg Victoria
Upstand	Yes	Handle Colour	Brushed stainless steel
Hob colour	Black enamel	Glass type	Black
Command panel finish	Enamelled metal	Plinth	Anthracite
Control knobs	Smeg Victoria	Logo	assembled 50's
Controls colour	Stainless steel	Logo position	Upstand+ Command panel

Programme / Functions

No. of cooking functions 5

Traditional cooking functions

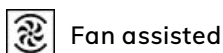

Cleaning functions



Other functions



Programs / Functions Auxiliary Oven

Cooking functions cavity 2 1
 Traditional cooking functions, cavity 2



Programs / Functions Third Oven

No. of functions third oven 1
 Oven light 
 Full grill 

Hob technical features



Total no. of cook zones 5

Front left - Induction - single - 2.30 kW - Booster 3.00 kW - - Ø 21.0 cm

Rear left - Induction - single - 1.40 kW - - Ø 18.0 cm

Central - Induction - single - 2.30 kW - Booster 3.00 kW - - Ø 27.0 cm

Rear right - Induction - single - 1.40 kW - - Ø 18.0 cm

Front right - Induction - single - 2.30 kW - Booster 3.00 kW - - Ø 21.0 cm

Automatic switch off when overheat	Yes	Minimum pan diameter indication	Yes
Automatic pan detection	Yes	Selected zone indicator	Yes

Main Oven Technical Features



No. of lights	1	Removable inner door	Yes
Fan number	1	Total no. of door glasses	3
Net volume of the cavity	61 l	No. of thermo-reflective door glasses	1
Gross volume, 1st cavity	70 l	Safety Thermostat	Yes
Cavity material	Ever Clean enamel	Usable cavity space dimensions (HxWxD)	316x460x412 mm
No. of shelves	4	Temperature control	Electro-mechanical
Type of shelves	Metal racks	Lower heating element power	1200 W
Light type	Halogen	Upper heating element - Power	1000 W
Light Power	40 W	Grill element	1700 W
Cooking time setting	Start and Stop	Large grill - Power	2700 W
Door opening	Side opening		
Side opening door	Yes		
Removable door	Yes		

Full glass inner door Yes

Circular heating element 2000 W
- Power

Grill type Electric

Tilting grill Yes

Options Main Oven

Timer Yes

End of cooking acoustic alarm Yes

Minimum Temperature 50 °C

Maximum temperature 245 °C

Second Oven Technical Features



Fan number 1
 Net volume of the second cavity 62 l
 Gross volume, 2nd cavity 69 l
 Cavity material Ever Clean enamel
 No. of shelves 9
 Type of shelves Metal racks
 No. of lights 1
 Light type Halogen
 Light Power 40 W
 Door opening Side opening
 Side opening door Yes

Removable door Yes
 Full glass inner door Yes
 Removable inner door Yes
 No. total door glasses 1
 No. thermo-reflective door glasses 1
 Safety Thermostat Yes
 Cooling system Tangential
 Usable cavity space dimensions (HxWxD) 605x275x370 mm
 Temperature control Electro-mechanical
 Circular heating element 2500 W
 - Power

Options Auxiliary Oven

Minimum Temperature 50 °C

Maximum temperature 245 °C

Third Oven Technical Features



Net volume, 3rd cavity 36 l
 Gross volume, 3rd cavity 41 l
 Cavity material Ever Clean enamel
 No. of shelves 2
 Type of shelves Metal racks
 No. of lights 1
 Light type Halogen
 Light Power 40 W
 Door opening Flap down
 Removable door Yes
 Full glass inner door Yes

Removable inner door Yes
 No. total door glasses 3
 No. of thermo-reflective door glasses 1
 Safety Thermostat Yes
 Cooling system Tangential
 Usable cavity space dimensions (HxWxD) 169x440x443 mm
 Temperature control Electro-mechanical
 Large grill - Power 2700 W
 Grill type Electric
 Tilting grill Yes

Options Third Oven

Minimum Temperature 50 °C

Maximum temperature 260 °C

Accessories included for Main Oven & Hob



Rack with back and side stop
40mm deep tray 1

Grill mesh 1
Telescopic Guide rails, partial Extraction 1

Accessories included for Secondary Oven



Oven grid with back stop 4

Plate rack/warmer 1

Accessories included for Third Oven

Rack with back and side stop 1

40mm deep tray 1

Electrical Connection

Electrical connection rating 15000 W
Current 42 A
Voltage 220-240 V
Voltage 2 (V) 380-415 V
Type of electric cable installed Yes, Single phase

Power supply cable length 150 cm
Additional connection modalities Yes, Double and Three Phase
Frequency 50 Hz
Terminal block 5 poles

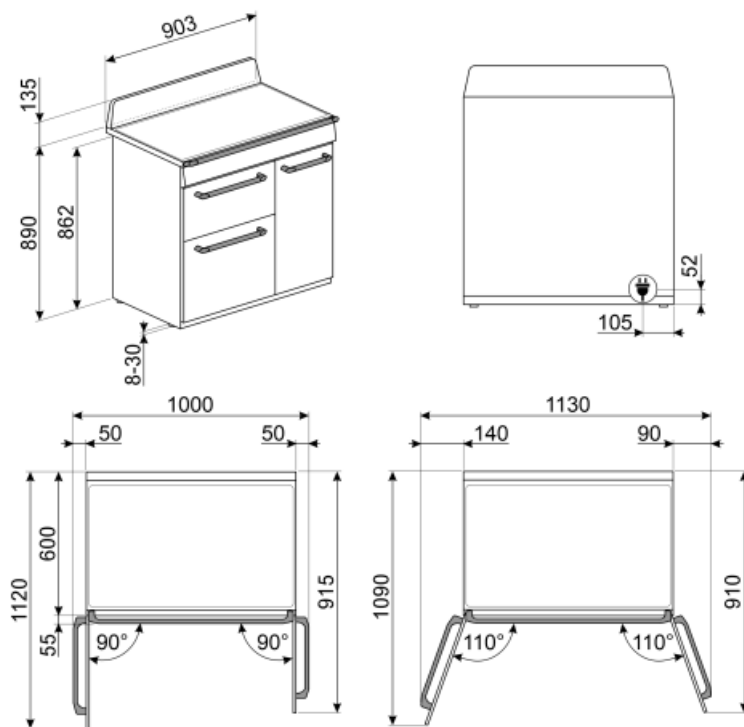

Not included accessories

KIT600TR93

Cover strip for hob back side, suitable for TR93 Victoria cookers



SFLK1

Child lock



PRTX

Refractory pizza stone with handles. D=35cm Not suitable for microwave ovens. Suitable for gas ovens, to be put on the griddle.



GRILLPLATE

Universal griddle for induction, gas, ceramic and electric hobs. Non-stick surface ideal for cooking meat, cheese and vegetables. Dimensions: 410 x 240 mm.



BN620-1

Enamelled tray suitable for 45cm and 60cm ovens. Depth 20 mm. Perfect for a wide range of savoury and sweet baking.



KITH93

Height extension kit (950mm), black, suitable for TR93 cookers (945-960mm)



TPKPLATE

Universal plate for induction, gas, ceramic and electric hobs. Non-stick surface ideal for cooking fish, eggs and vegetables. Dimensions: 410 X 240 mm.



KITP65TR93

Depth extension kit (650 mm), nero, suitable for TR93 cookers



GTP

Partially extractable telescopic guides (1 level), suitable for traditional ovens. Made in stainless steel, they guarantee stability and facilitate the smooth extraction of the trays.



BNP608T

Teflon-coated tray, 8mm depth, to be placed on the grid



KIT1TR9N

Splashback black, 90cm ,suitable for TR90 and TR93 Victoria cookers



SCRP

Non-scratch hob scraper - suitable for induction and ceramic hobs



GT1P-2

Partially extractable telescopic guides (1 level) for ovens with metal frames. Length: 355.5 mm, extraction: 285 mm. Material: Stainless steel AISI 430 polished.



PALPZ

Pizza shovel with folding handle. Dimensions L31.5 x H32.5 cm. Easy and convenient to use and store. Perfect for serving pizza, bread and savory pastries in a safe and professional way.



GTT



Totally extractable telescopic guides (1 level), suitable for traditional ovens. Made in stainless steel, they guarantee stability and facilitate the smooth extraction of the trays.

SMOLD

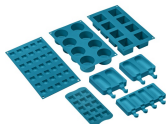

















Set of 7 silicone moulds for ice creams, ice lollies, pralines, ice cubes or to portion food. Usable from -60°C to +230°C

















BN640

Enamelled tray suitable for 45cm and 60cm ovens. Depth 540 mm. Perfect for cooking and roasting meat and fish in sauces. Also ideal for experimenting with lighter and crunchy side dishes

Symbols glossary (TT)

 <p>Child lock: some models are fitted with a device to lock the programme/cycle so it cannot be accidentally changed.</p>	 <p>Air cooling system: to ensure a safe surface temperatures.</p>
 <p>Defrost by time: Manual defrost function. At the end of the set duration, the function stops.</p>	 <p>Triple glazed doors: Number of glazed doors.</p>
 <p>ECO-logic: option allows you to restrict the power limit of the appliance real energy saving.</p>	 <p>A: Product drying performance, measured from A+++ to D / G depending on the product family</p>
 <p>B: Product energy rating, measured from A+++ to D / G depending on the product family.</p>	 <p>Ever Clean Enamel: Ever Clean enamel is applied electrostatically, corner to corner and edge to edge to prevent cracking or cracks over time. It is a particular pyrolytic enamel, resistant to acids which, in addition to being pleasantly bright, promotes greater cleaning of the oven walls, thanks to its lower porosity. It is baked at over 850 ° C and slowly polymerized at a scientifically determined rate to ensure uniform depth and strength Ever Clean enamel creates an impeccable finish both on the inside of the oven and on the trays, making the surfaces of the oven incredibly easy to maintain over time as it reduces the adhesion of fat during cooking</p>
 <p>Fan assisted base: the mix of fan and lower heating element alone allows to finish cooking foods already cooked on the surface but not internally more quickly. This system is recommended to finish cooking foods that are already well cooked on the surface, but not internally, which therefore require a moderate higher heat. Ideal for any type of food.</p>	 <p>Fan assisted: Intense and homogeneous traditional cooking, also suitable for complex recipes. The fan is active and the heat comes from below and from above at the same time. Ventilated cooking ensures a faster and more homogeneous result, leaving fragrant foods outside and moister inside. Ideal for baked pasta, biscuits, roasts and cobblers.</p>
 <p>Static: Traditional cooking suitable for the preparation of one dish at a time. The fan is not active and the heat comes from below and from above at the same time. Static cooking is slower and more delicate, ideal in order to get well cooked and dry dishes even inside. Ideal for cooking all types of roasts, fatty meats, bread, filled cakes.</p>	 <p>Circulaire: it is the perfect function for cooking all types of dishes in a more delicate way. The heat comes from the back of the oven and is distributed quickly and evenly The fan is active. It is also ideal for cooking on multiple levels without mixing smells and flavors.</p>
 <p>ECO: low energy consumption cooking: this function is particularly suitable for cooking on a single shelf with low energy consumption. It is recommended for all types of food except those that can generate a lot of moisture (for example vegetables). To achieve maximum energy savings and reduce time, it is recommended to put the food in the oven without preheating the cooking compartment</p>	 <p>Grill element: Using of grill gives excellent results when cooking meat of medium and small portions, especially when combined with a rotisserie (where possible). Also ideal for cooking sausages and bacon.</p>
 <p>Light</p>	 <p>Overheat protection: The safety system that automatically turns off the hob in case of overheating of the control unit.</p>

- | | |
|--|---|
|  <p>Induction: The work of these hobs is based on the principle of electromagnetic induction. The heat is generated directly in the bottom of the pan during its contact with the hob.</p> |  <p>All glass inner door: All glass inner door, a single flat surface which is simple to keep clean.</p> |
|  <p>The inner door glass: can be removed with a few quick movements for cleaning.</p> |  <p>Side lights: Two opposing side lights increase visibility inside the oven.</p> |
|  <p>Plate rack warming: function for heating or keeping dishes warm. Place the baking tray on the lowest shelf and stack the dishes to be heated.</p> |  <p>The oven cavity has 2 different cooking levels.</p> |
|  <p>The oven cavity has 4 different cooking levels.</p> |  <p>The oven cavity has 9 different cooking levels.</p> |
|  <p>Telescopic rails: allow you to pull out the dish and check it without having to remove it from the oven entirely.</p> |  <p>Electronic control: Allows you to maintain temperature inside the oven with the precision 2-3 ° C. This enables to cook meals that are very sensitive to temperature changes, such as cakes, souffles, puddings.</p> |
|  <p>Tilting grill: the tilting grill can be easily unhooked to move the heating element and clean the roof of the appliance in one simple step.</p> |  <p>Vapor Clean: a simple cleaning function using steam to loosen deposits in the oven cavity.</p> |
|  <p>The capacity indicates the amount of usable space in the oven cavity in litres.</p> |  <p>The capacity indicates the amount of usable space in the oven cavity in litres.</p> |
|  <p>The capacity indicates the amount of usable space in the oven cavity in litres.</p> | |