

# TR4110IX2

Cooker size	110x60 cm
N. of cavities with energy label	2
Cavity heat source	ELECTRICITY
Hob type	Induction
Type of main oven	Thermo-ventilated
Type of second oven	Fan assisted
Cleaning system main oven	Vapor Clean
EAN code	8017709312473
Energy efficiency class	A
Energy efficiency class, second cavity	A



## Aesthetics

<b>Aesthetic</b>	Victoria	<b>Colour of buttons</b>	Black
<b>Colour</b>	Stainless steel	<b>No. of controls</b>	10
<b>Finishing</b>	Satin	<b>Serigraphy colour</b>	Black
<b>Design</b>	Victoria	<b>Handle</b>	Smeg Victoria
<b>Door</b>	With frame	<b>Handle Colour</b>	Brushed stainless steel
<b>Upstand</b>	Yes	<b>Glass type</b>	Black
<b>Hob colour</b>	Black enamel	<b>Plinth</b>	Anthracite
<b>Command panel finish</b>	Stainless steel	<b>Storage compartment</b>	Drawer
<b>Control knobs</b>	Smeg Victoria	<b>Logo</b>	assembled 50's
<b>Controls colour</b>	Stainless steel	<b>Logo position</b>	Upstand
<b>Display</b>	electronic 5 buttons		

## Programme / Functions

**No. of cooking functions** 5  
**Traditional cooking functions**



Static



Fan assisted



Circulaire



Eco



Fan assisted bottom

**Cleaning functions**



Vapor clean

### Other functions

 Defrost by time

## Programs / Functions Auxiliary Oven

Cooking functions cavity 2 6

Traditional cooking functions, cavity 2

 Static

 Fan assisted

 Eco

 Large grill

 Fan grill (large)

 Fan-assisted bottom

Cleaning functions cavity 2

 Vapor clean

## Programs / Functions Third Oven

No. of functions third oven 1

Oven light 

Full grill 

## Hob technical features



Total no. of cook zones 5

Front left - Induction - single - 2,3 kW - Booster 3 kW - - Ø 21.0 cm

Rear left - Induction - single - 1,3 kW - Booster 1,4 kW - - Ø 18.0 cm

Central - Induction - single - 2,3 kW - Booster 3 kW - - Ø 27.0 cm

Rear right - Induction - single - 1,3 kW - Booster 1,4 kW - - Ø 18.0 cm

Front right - Induction - single - 2,3 kW - Booster 3 kW - - Ø 21.0 cm

Automatic switch off when overheat Yes

Minimum pan diameter indication Yes

Automatic pan detection Yes

Selected zone indicator Yes

## Main Oven Technical Features



No. of lights 1

Fan number 1

Net volume of the cavity 61 l

Gross volume, 1st cavity 70 l

Cavity material Ever Clean enamel

Removable inner door Yes

Total no. of door glasses 3

No. of thermo-reflective door glasses 1

Safety Thermostat Yes

<b>No. of shelves</b>	4	<b>Cooling system</b>	Tangential
<b>Type of shelves</b>	Metal racks	<b>Usable cavity space dimensions (HxWxD)</b>	316x460x412 mm
<b>Light type</b>	Halogen	<b>Temperature control</b>	Electro-mechanical
<b>Light Power</b>	40 W	<b>Lower heating element power</b>	1200 W
<b>Cooking time setting</b>	Start and Stop	<b>Upper heating element - Power</b>	1000 W
<b>Door opening</b>	Side opening	<b>Grill element</b>	1700 W
<b>Side opening door</b>	Yes	<b>Large grill - Power</b>	2700 W
<b>Removable door</b>	Yes	<b>Circular heating element - Power</b>	2700 W
<b>Full glass inner door</b>	Yes	<b>Grill type</b>	Electric

## Options Main Oven

<b>Timer</b>	Yes	<b>Minimum Temperature</b>	50 °C
<b>End of cooking acoustic alarm</b>	Yes	<b>Maximum temperature</b>	260 °C

## Second Oven Technical Features



<b>Fan number</b>	1	<b>Removable inner door</b>	Yes
<b>Net volume of the second cavity</b>	61 l	<b>No. total door glasses</b>	3
<b>Gross volume, 2nd cavity</b>	70 l	<b>No. thermo-reflective door glasses</b>	1
<b>Cavity material</b>	Ever Clean enamel	<b>Safety Thermostat</b>	Yes
<b>No. of shelves</b>	4	<b>Cooling system</b>	Tangential
<b>Type of shelves</b>	Metal racks	<b>Usable cavity space dimensions (HxWxD)</b>	316x444x425 mm
<b>No. of lights</b>	1	<b>Temperature control</b>	Electro-mechanical
<b>Light type</b>	Halogen	<b>Lower heating element - power</b>	1200 W
<b>Light Power</b>	40 W	<b>Upper heating element - Power</b>	1000 W
<b>Door opening</b>	Side opening	<b>Grill element - power</b>	1700 W
<b>Side opening door</b>	Yes	<b>Large grill - Power</b>	2700 W
<b>Removable door</b>	Yes	<b>Grill type</b>	Electric
<b>Full glass inner door</b>	Yes	<b>Tilting grill</b>	Yes

## Options Auxiliary Oven

<b>Minimum Temperature</b>	50 °C	<b>Maximum temperature</b>	260 °C
----------------------------	-------	----------------------------	--------

## Third Oven Technical Features



<b>Net volume, 3rd cavity</b>	36 l	<b>Removable inner door</b>	Yes
<b>Gross volume, 3rd cavity</b>	41 l	<b>No. total door glasses</b>	3
<b>Cavity material</b>	Ever Clean enamel	<b>No. of thermo-reflective door glasses</b>	1
<b>No. of shelves</b>	2	<b>Safety Thermostat</b>	Yes
<b>Type of shelves</b>	Metal racks	<b>Cooling system</b>	Tangential
<b>No. of lights</b>	1	<b>Usable cavity space dimensions (HxWxD)</b>	169x440x443 mm
<b>Light type</b>	Incandescent	<b>Temperature control</b>	Electro-mechanical
<b>Light Power</b>	25 W	<b>Large grill - Power</b>	2700 W
<b>Door opening</b>	Flap down	<b>Grill type</b>	Electric
<b>Removable door</b>	Yes	<b>Tilting grill</b>	Yes
<b>Full glass inner door</b>	Yes		

## Options Third Oven

<b>Minimum Temperature</b>	50 °C	<b>Maximum temperature</b>	260 °C
----------------------------	-------	----------------------------	--------

## Accessories included for Main Oven & Hob



<b>Rack with back and side stop</b>	2	<b>Grill mesh</b>	1
<b>40mm deep tray</b>	1	<b>Telescopic Guide rails, partial Extraction</b>	1

## Accessories included for Secondary Oven



<b>Rack with back and side stop</b>	2	<b>Grill mesh</b>	1
<b>40mm deep tray</b>	1	<b>Telescopic Guide rails, partial Extraction</b>	1

## Accessories included for Third Oven

<b>Rack with back and side stop</b>	1	<b>40mm deep tray</b>	1
-------------------------------------	---	-----------------------	---

## Electrical Connection

<b>Electrical connection rating</b>	16500 W	<b>Power supply cable length</b>	150 cm
<b>Current</b>	46 A	<b>Additional connection modalities</b>	Yes, Double and Three Phase
<b>Voltage</b>	220-240 V	<b>Frequency</b>	50 Hz
<b>Voltage 2 (V)</b>	380-415 V	<b>Terminal block</b>	5 poles
<b>Type of electric cable installed</b>	Yes, Single phase		

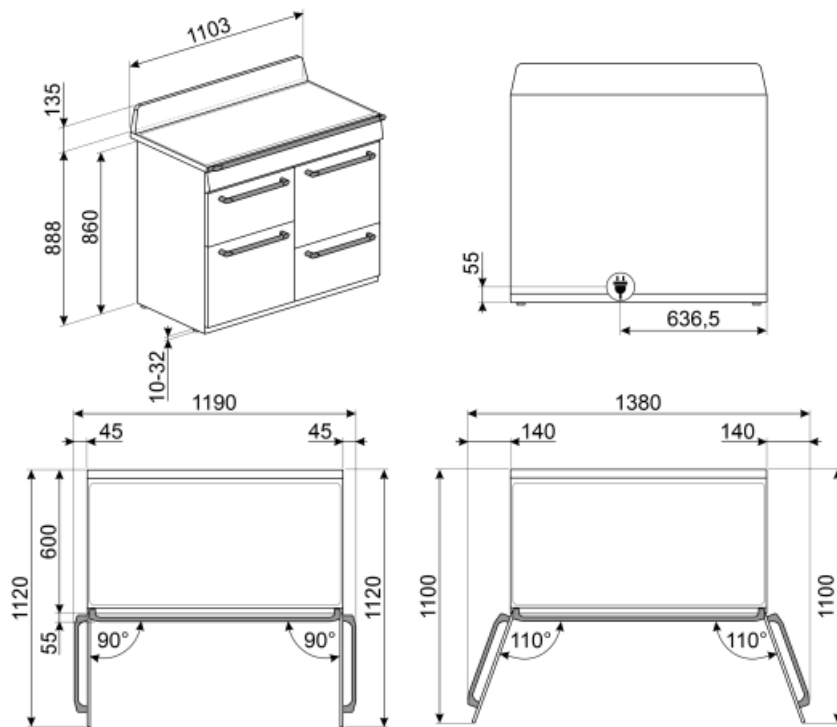

## Not included accessories



### KITH4110

Height extension kit (950mm), black, suitable for TR4110 cookers (945-965mm)



### SFLK1

Child lock



### PRTX

Refractory pizza stone with handles. D=35cm Not suitable for microwave ovens. Suitable for gas ovens, to be put on the griddle.



### GRILLPLATE

Universal griddle for induction, gas, ceramic and electric hobs. Non-stick surface ideal for cooking meat, cheese and vegetables. Dimensions: 410 x 240 mm.



### BN620-1

Enamelled tray suitable for 45cm and 60cm ovens. Depth 20 mm. Perfect for a wide range of savoury and sweet baking.



### SCRP

Non-scratch hob scraper - suitable for induction and ceramic hobs



### AIRFRY

Air fryer rack AIRFRY . Ideal for recreating traditional frying in the oven, but with fewer calories and less fat. It allows you to cook quickly and simply dishes such as French fries, fried vegetables and fish, ensuring perfect browning and crispiness.



### GTP

Partially extractable telescopic guides (1 level), suitable for traditional ovens. Made in stainless steel, they guarantee stability and facilitate the smooth extraction of the trays.



### BNP608T

Teflon-coated tray, 8mm depth, to be placed on the grid



### KIT1TR41N

Splashback black, 110cm ,suitable for TR4110 Victoria cookers



### KITP65TR41

Depth extension kit (650 mm), black, suitable for TR4110 cookers



### GT1P-2

Partially extractable telescopic guides (1 level) for ovens with metal frames. Length: 355.5 mm, extraction: 285 mm. Material: Stainless steel AISI 430 polished.

### KIT600TR4110

Cover strip for hob back side, suitable for TR4110 Victoria cookers



### TPKPLATE

Universal plate for induction, gas, ceramic and electric hobs. Non-stick surface ideal for cooking fish, eggs and vegetables. Dimensions: 410 X 240 mm.



### GTT

Totally extractable telescopic guides (1 level), suitable for traditional ovens. Made in stainless steel, they guarantee stability and facilitate the smooth extraction of the trays.



### SMOLD

Set of 7 silicone moulds for ice creams, ice lollies, pralines, ice cubes or to portion food. Usable from -60°C to +230°C

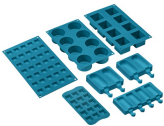

### BBQ

Double sided plate BBQ. Suitable for recreating succulent and crispy dishes in the oven with the typical taste of grilled cooking. The ribbed side is particularly suitable for meats and cheeses. The smooth side for fish, seafood and vegetables.



### PALPZ

Pizza shovel with folding handle. Dimensions L31.5 x H32.5 cm. Easy and convenient to use and store. Perfect for serving pizza, bread and savory pastries in a safe and professional way.



















### BN640













Enamelled tray suitable for 45cm and 60cm ovens. Depth 540 mm. Perfect for cooking and roasting meat and fish in sauces. Also ideal for experimenting with lighter and crunchy side dishes



## Symbols glossary (TT)

 <p>A: Product drying performance, measured from A+++ to D / G depending on the product family</p>	 <p>Child lock: some models are fitted with a device to lock the programme/cycle so it cannot be accidentally changed.</p>
 <p>Air cooling system: to ensure a safe surface temperatures.</p>	 <p>Defrost by time: Manual defrost function. At the end of the set duration, the function stops.</p>
 <p>Triple glazed doors: Number of glazed doors.</p>	 <p>ECO-logic: option allows you to restrict the power limit of the appliance real energy saving.</p>
 <p>Ever Clean Enamel: Ever Clean enamel is applied electrostatically, corner to corner and edge to edge to prevent cracking or cracks over time. It is a particular pyrolytic enamel, resistant to acids which, in addition to being pleasantly bright, promotes greater cleaning of the oven walls, thanks to its lower porosity. It is baked at over 850 ° C and slowly polymerized at a scientifically determined rate to ensure uniform depth and strength Ever Clean enamel creates an impeccable finish both on the inside of the oven and on the trays, making the surfaces of the oven incredibly easy to maintain over time as it reduces the adhesion of fat during cooking</p>	 <p>Fan assisted base: the mix of fan and lower heating element alone allows to finish cooking foods already cooked on the surface but not internally more quickly. This system is recommended to finish cooking foods that are already well cooked on the surface, but not internally, which therefore require a moderate higher heat. Ideal for any type of food.</p>
 <p>Fan assisted: Intense and homogeneous traditional cooking, also suitable for complex recipes. The fan is active and the heat comes from below and from above at the same time. Ventilated cooking ensures a faster and more homogeneous result, leaving fragrant foods outside and moister inside. Ideal for baked pasta, biscuits, roasts and cobblers.</p>	 <p>Static: Traditional cooking suitable for the preparation of one dish at a time. The fan is not active and the heat comes from below and from above at the same time. Static cooking is slower and more delicate, ideal in order to get well cooked and dry dishes even inside. Ideal for cooking all types of roasts, fatty meats, bread, filled cakes.</p>
 <p>Circulaire: it is the perfect function for cooking all types of dishes in a more delicate way. The heat comes from the back of the oven and is distributed quickly and evenly The fan is active. It is also ideal for cooking on multiple levels without mixing smells and flavors.</p>	 <p>ECO: low energy consumption cooking: this function is particularly suitable for cooking on a single shelf with low energy consumption. It is recommended for all types of food except those that can generate a lot of moisture (for example vegetables). To achieve maximum energy savings and reduce time, it is recommended to put the food in the oven without preheating the cooking compartment</p>
 <p>Grill: Very intense heat coming only from above from a double heating element. The fan is not active. Provides excellent grilling and gratinating results. Used at the end of cooking, it gives a uniform browning to dishes.</p>	 <p>Grill element: Using of grill gives excellent results when cooking meat of medium and small portions, especially when combined with a rotisserie (where possible). Also ideal for cooking sausages and bacon.</p>
 <p>Fan grill: very intense heat coming only from above from a double heating element The fan is active. It allows the optimal grilling of thickest meats. Ideal for large cuts of meat.</p>	 <p>Light</p>



- 
- |   |   |   |   |
|---|---|---|---|
|   | <p>Overheat protection: The safety system that automatically turns off the hob in case of overheating of the control unit.</p>  |  | <p>Induction: The work of these hobs is based on the principle of electromagnetic induction. The heat is generated directly in the bottom of the pan during its contact with the hob.</p> |
|   | <p>All glass inner door: All glass inner door, a single flat surface which is simple to keep clean.</p>   |  | <p>The inner door glass: can be removed with a few quick movements for cleaning.</p>  |
|   | <p>Side lights: Two opposing side lights increase visibility inside the oven.</p>   |  | <p>The oven cavity has 2 different cooking levels.</p>  |
|   | <p>The oven cavity has 4 different cooking levels.</p>  |  | <p>Telescopic rails: allow you to pull out the dish and check it without having to remove it from the oven entirely.</p>  |
|   | <p>Electronic control: Allows you to maintain temperature inside the oven with the precision 2-3 ° C. This enables to cook meals that are very sensitive to temperature changes, such as cakes, souffles, puddings.</p> |  | <p>Tilting grill: the tilting grill can be easily unhooked to move the heating element and clean the roof of the appliance in one simple step.</p>  |
|   | <p>Vapor Clean: a simple cleaning function using steam to loosen deposits in the oven cavity.</p>   |  | <p>The capacity indicates the amount of usable space in the oven cavity in litres.</p>  |
|  | <p>The capacity indicates the amount of usable space in the oven cavity in litres.</p>  |   |   |