

S8C1721F



Product Family	Refrigerator
Installation	Built-in
Category	One Door
Built-in niche	178
Reference width	Until 60
Reference height	160 - 200
Cooling type	Fan assisted
Defrost	Automatic for refrigerator, manual for freezer
Hinge type	Sliding
Hinge position	Right
Reversible door	Yes
EAN code	8017709294700



Aesthetics



Aesthetic	Universale	Logo	Silk screen
Colour	White	Door shelves profile color	Silver
Material	Metal sheet	Drawers profile color	Silver
Logo colour	Black	Color of glass shelf profile	Chrome
Side material	Steel	Display	LED
Side colour	White	Display position	Interno (cella frigo)

Refrigerator compartment features



No. of adjustable shelves	4	Crisper Cover	Yes
Number of fruit and vegetables drawers	1	Type of crisper/vegetable drawers cover	Glass
Type of adjustable shelves	Glass	Internal light in fridge	Yes
Type of crisper/vegetable drawers cover	On sliding rails	Type of internal light (fridge)	LED

Refrigerator Inner Door

No. of door shelves with transparent cover	1	No. of bottle shelves	1
--	---	-----------------------	---

Number of adjustable door shelves 3

Other Refrigerator features



Accessories Egg tray Fan Yes

Freezer compartment features

Internal freezer compartment Yes

Other technical features



Functions display	Fast freezing
Type of temperature control	Electronic
No. of compressors	1
Refrigerant gas type	R600a
Type of compressor	Standard
Refrigerant Quantity (gr)	44 g
Foam agent	Cyclopentane

Performance / Energy Label NEW 2019









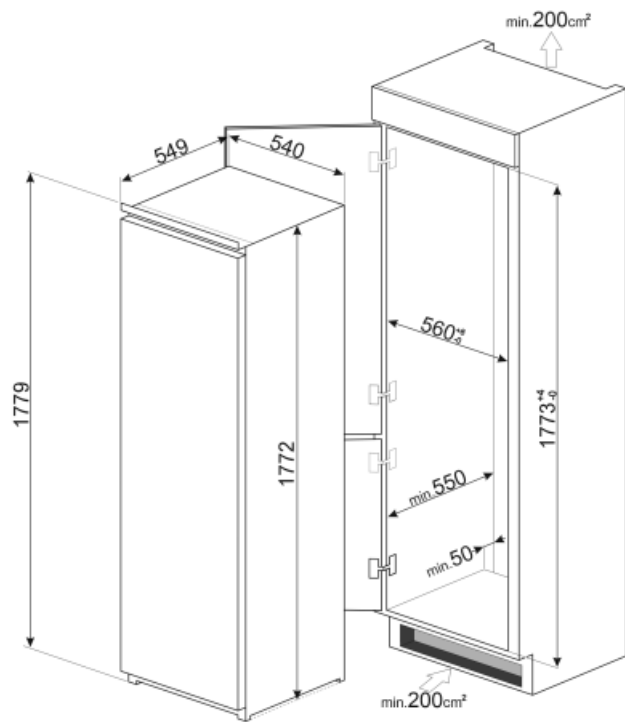

Annual energy consumption	206 kWh/a	Airborne acoustical noise emissions	32 dB(A) re 1pW
Energy efficiency class	F	Temperature Rise Time	14 h
Airborne acoustical noise emission class	B	4 star - Freezing capacity	5.7 Kg/24h
Total net volume	282 l	Climate class	SN, N, ST, T
Sum of the volumes of the frozen compartment(s)	22 l	EEL	124 %
Sum of the volumes of the chill compartment(s) and the unfrozen compartment(s)	260 l		

Electrical Connection

Plug	(F;E) Schuko	Voltage (V)	230-240 V
Electrical connection rating	130 W	Frequency (Hz)	50 Hz
Current	1 A	Power supply cable length	240 cm



Symbols glossary (TT)

	The automatic defrost system works by automatically defrosting at regular intervals eliminating the need to defrost altogether.		LED display: to show programmes, functions and options selected and the time to the end of the cycle.
	Energy efficiency class F		A++: Energy efficiency class A++ helps to save up to 20% energy compared to class A. Maximum performance with minimum consumption is guaranteed.
	Ventilated: Forced distribution of cold air in the refrigerator compartment, which allows even temperature distribution within the fridge.		Fast freezing: The fast freezing function brings the temperature of the compartment down when activated a few hours prior to usage.
	LED interior lighting: is a more energy efficient and long lasting way of illuminating the interior of the appliance.		Built-in niche