

S4C102F

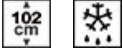

Product Family	Refrigerator
Installation	Built-in
Category	One Door
Built-in niche	102
Reference width	Until 60
Reference height	100 - 160
Cooling type	Static
Defrost	Automatic for refrigerator, manual for freezer
Hinge type	Sliding
Hinge position	Right
Reversible door	Yes
EAN code	8017709295448



Aesthetics

Aesthetics	Universal	Side colour	White
Colour	White	Logo	Silk screen
Material	Metal sheet	Door shelves profile colour	White
Side material	Steel	Colour of glass shelf profile	White

Refrigerator compartment features



No. of adjustable shelves	2	Crisper Cover	Yes
Number of fruit and vegetables drawers	1	Type of crisper/vegetable drawers cover	Glass
Type of adjustable shelves	Glass	Internal light in fridge	Yes
Type of crisper/vegetable drawers cover	Standard	Type of internal light (fridge)	LED

Refrigerator Inner Door

No. of door shelves with transparent cover	1	No. of bottle shelves	1
Number of adjustable door shelves	2		

Other Refrigerator features

Accessories Egg tray

Freezer compartment features

Internal freezer compartment Yes

Other technical features

Freezer compartment accessories	Ice cube tray
Type of temperature control	Electro-mechanical
No. of compressors	1
Refrigerant gas type	R600a
Type of compressor	Standard
Refrigerant Quantity (gr)	34 g
Foam agent	Cyclopentane

Performance / Energy Label NEW





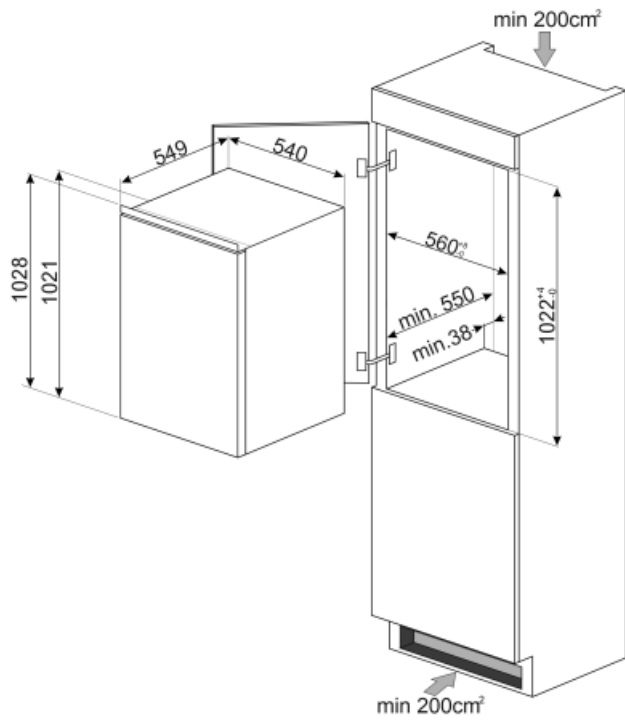

			
Annual energy consumption	185 kWh/year	Noise level	36 dB(A) re 1pW
Energy efficiency class	F	Thaw time	7.90 h
Airborne acoustical noise emission class	C	4 star - Freezing capacity	2.6 Kg/24h
Total volume	164 l	Climatic class	N, ST
Sum of the volumes of the frozen compartment(s)	17 l	EI	124 %
Sum of the volumes of the chill compartment(s) and the unfrozen compartment(s)	147 l		

Electrical Connection

Plug	(F;E) Schuko	Voltage (V)	230-240 V
Nominal power	100 W	Frequency (Hz)	50 Hz
Current	0.7 A	Power supply cable length	240 cm



Symbols glossary

- | | | | |
|--|---|---|--|
|  | 4 stars freezing compartment for better food preservation. |  | A++: Energy efficiency class A++ helps to save up to 20% energy compared to class A. Maximum performance with minimum consumption is guaranteed. |
|  | The automatic defrost system works by automatically defrosting at regular intervals eliminating the need to defrost altogether. |  | LED interior lighting: is a more energy efficient and long lasting way of illuminating the interior of the appliance. |
|  | Built-in niche |  | Energy efficiency class F |