

VZP76N

Sink material Composite
 Type Composite bowl
 No. of bowls 1
 EAN code 8017709294038



Aesthetics



Aesthetic	Universale	Logo	On overflow
Serie	Quadra	Alternative colours available	Dove Gray, White, Cemento / Concrete
Colour	Black	Tap hole / precut tap hole	No Taphole
Building in type	Standard, Undermount		

	Bowl type	Bowl dimensions, WxDxH (mm)	Bowl depth (mm)	Radius corner bowl	Overflow	Strainer position	Strainer dimension
Bowl	Minimum radius	700 x 400 x 215	215	10	Yes, flush fitted	Wall position	3.5"

Technical Features



Characteristics composite material	Antibacterial, Anti-scratch, Termal schock resistant, High temperatures resistant, Impact resistant, Easy to clean, UV Resistant	Height from kitchen top	6 mm
Dimensions of the product (mm)	215x756x456 mm	Base unit size	80 cm
Cutout dimension topmount (mm)	746x446 mm	No. of clips	4
Cutout dimension undermount (mm)	700x400 mm	Type of clips	Standard + undermount clip

Undermount cutout radius 10 mm

Accessories Included

Accessories for installation Strainer, Savespace siphon with dishwasher outlet connection, Fixing clips

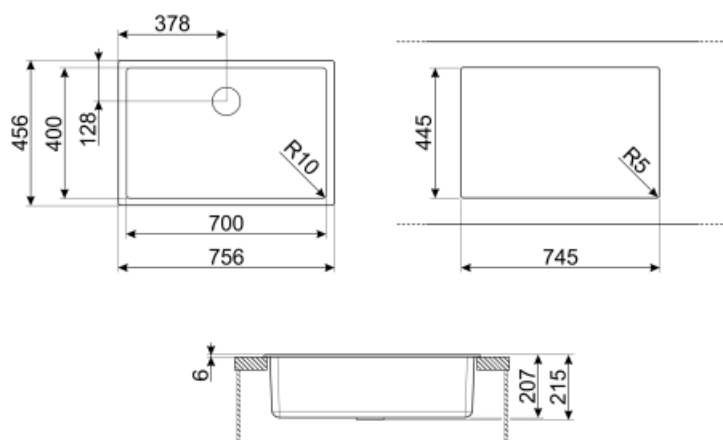

Not included accessories



KITFD050

Waste disposal 0,5 HP, Motor: 1/2 horsepower, Fits all sinks with 3 1/2" waste outlet



KITFD100

Waste disposal 1 HP, Motor: 1/2 horsepower, Fits all sinks with 3 1/2" waste outlet



COL19H

St/Steel colander to fit MINIMUM radius mm bowl, measures 200 x 410 x 100 mm



KITDSQ

Soap dispenser chrome finishing with square knob 40x40 mm



KITFD075

Waste disposal 0,75 HP, Motor: 1/2 horsepower, Fits all sinks with 3 1/2" waste outlet

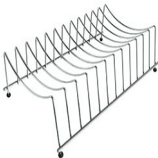

COLPTX

Draining rack base 300 x 185 x 82 mm



COL36

St/steel colander for MINIMUM radius bowls, measures 370 x 410 x 30 mm



MATROL

Stainless steel drainer 405 x 340 mm



COL19

St/Steel colander to fit MINIMUM radius mm bowl, measures 200 x 410 x 26 mm



CB25MN

Single HPE chopping board to fit minimum radius bowls, black matt, measures 250 x 410 H 12 mm, dishwasher safe



DBSINT34











St/steel drain basket to fit STD radius composite sinks 340 x 400 mm bowl, 180 mm depth



CB28QU

Single HPL chopping board for minimum radius, oak, measures 280 x 418 H 12 mm

Symbols glossary (TT)

	Antibacterial		Antiscratch
	Cupboard width required for sink installation		Sink depth - depending on the model, the depth can be from 13 to 24,5
	Standard installation: Traditional installation in tabletop, suitable for any kitchen sets		Under table top installation: The sink is fixed under tabletop, which extends the work surface and the depth of the sink.
	Easy to clean		High temperatures resistant
	Thermal shock resistant		Impact resistant
	UV protection, does not fade over time.		