

VFU50SFR

Sink material Stainless steel
 Type Monoblock bowl
 No. of bowls 1
 EAN code 8017709304669



Aesthetics



Serie	Mira	Building in type	Flush fitted, Flat, Undermount
Aesthetic	Universale	Logo	Embossed
Color	Stainless steel	Tap hole / precut tap hole	No Taphole
Finishing	Brushed		

	Bowl type	Bowl dimensions, WxDxH (mm)	Bowl depth (mm)	Radius corner bowl	Overflow	Strainer position	Strainer dimension
Bowl	Minimum radius	500 x 400 x 200	200	15	Yes, flush fitted	Wall position	3.5"

Technical Features



Dimensions of the product (mm)	200x540x440 mm	Height from kitchen top	1 mm
Cutout dimension topmount (mm)	525*425 mm	Base unit size	60 cm
Cutout dimension undermount (mm)	504*404 mm	No. of clips	8
Undermount cutout radius	17 mm	Type of clips	Standard + undermount clip

Accessories Included

**Accessories for
installation**

Strainer, Savespace siphon
with dishwasher outlet
connection, Fixing clips,
Silicone

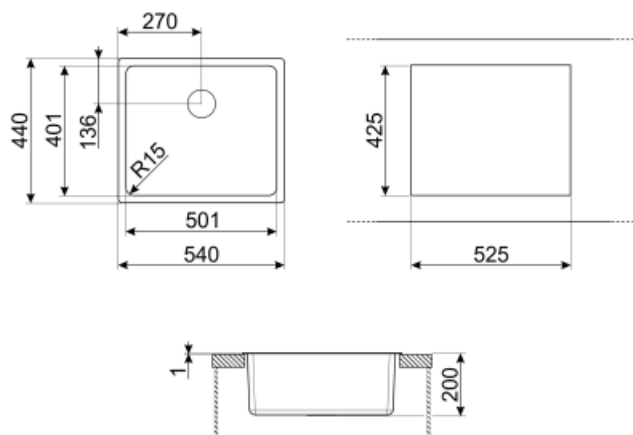

Not included accessories



RND1V

Rondò waste kit 1 bowl with standard overflow



KITFD050

Waste disposal 0,5 HP, Motor: 1/2 horsepower, Fits all sinks with 3 1/2" waste outlet



DB34

St/steel drain basket to fit STD radius 340 x 400 bowl, 180 mm depth



COL36

St/steel colander for MINIMUM radius bowls, measures 370 x 410 x 30 mm



KITFD100

Waste disposal 1 HP, Motor: 1/2 horsepower, Fits all sinks with 3 1/2" waste outlet



3712

Siphon single bowl sinks (dishwasher connection included)



3713

Siphon double bowls sinks (dishwasher connection included)



COL19H

St/Steel colander to fit MINIMUM radius mm bowl, measures 200 x 410 x 100 mm



COL19

St/Steel colander to fit MINIMUM radius mm bowl, measures 200 x 410 x 26 mm



KITDS

Soap dispenser chrome finishing with round knob



KITDSQ

Soap dispenser chrome finishing with square knob 40x40 mm



CB25MN

Single HPE chopping board to fit minimum radius bowls, black matt, measures 250 x 410 H 12 mm, dishwasher safe



KITFD075

Waste disposal 0,75 HP, Motor: 1/2 horsepower, Fits all sinks with 3 1/2" waste outlet



KITFD050UK



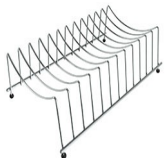

Waste disposal 0,5 HP, Motor: 1/2 horsepower, Fits all sinks with 3 1/2" waste outlet, UK



COLPTX

Draining rack base 300 x 185 x 82 mm

Symbols glossary (TT)

- | | | | |
|--|---|---|---|
|  | Cupboard width required for sink installation |  | Sink depth - depending on the model, the depth can be from 13 to 24,5 |
|  | Flat: Installation of product with flat edge. |  | Flush-fitted installation: Models of sinks/hobs which are integrated flush with the tabletop of a kitchen unit. |
|  | Under table top installation: The sink is fixed under tabletop, which extends the work surface and the depth of the sink. | | |