

## RF376RSIX



Product Family	Refrigerator
Installation	Free standing
Category	Bottom Mount
Built-in niche	>200
Reference width	70 - 80
Reference height	Higher than 200
Sistema Total No - Frost	Total
Cooling type	Fan assisted refrigerator, no-frost freezer
Defrost	Automatic
Hinge type	Door on door
Hinge position	Right
EAN code	8017709205041



## Aesthetics



Aesthetic	Classica	Logo colour	Chrome
Colour	Stainless steel	Side material	Stainless steel
Design	Flat	Side colour	Stainless steel
Material	Stainless steel	Logo	Applied
Handle	External	Display	LCD Touch
Handle type	Fixed	Water Filter	Internal
Handle colour	Stainless steel		

## Refrigerator compartment features

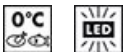

No. of adjustable shelves	3	Type of crisper/vegetable drawers cover	Glass
Number of fruit and vegetables drawers	1	Life Plus zone-0°C	Yes
Type of adjustable shelves	Glass	Internal light in fridge	Yes
Crisper Cover	Yes	Type of internal light (fridge)	LED

## Refrigerator Inner Door

Number of adjustable door shelves	2	Bottle shelves with wire support	Yes
No. of bottle shelves	1		

## Other Refrigerator features



MultiFlow Yes

## Freezer compartment features

Number of drawers	2	Type of internal light (freezer)	LED
Internal light in freezer	Yes		

## Other Freezer features

Ice maker	Automatic	Ice tray shelf	Yes
-----------	-----------	----------------	-----

## Other technical features



Functions display

Holiday, Fast freezing, Fast cooling, MultiZone, Control lock, Temperature alarm, Cooling timer, Demo Mode, Sabbath

MultiZone

Yes

Temperature alarm lamp

Yes

Temperature Alarm

Acoustic and visual

Type of temperature control

Electronic

No. of compressors

2

Refrigerant gas type

R600a

Type of compressor

Inverter

Refrigerant Quantity (gr)

58 g

Foam agent

Cyclopentane

## Performance / Energy Label NEW 2019



Annual energy consumption	323 kWh/a	Sum of the volumes of the chill compartment(s) and the unfrozen compartment(s)	320 l
Energy efficiency class	F	Airborne acoustical noise emissions	41 dB(A) re 1pW
Airborne acoustical noise emission class	C	Temperature Rise Time	10 h
Total net volume	320 l	Climate class	SN, N, ST, T
Sum of the volumes of the frozen compartment(s)	105 l	EEl	122 %

## Electrical Connection

---

<b>Plug</b>	(F;E) Schuko	<b>Voltage (V)</b>	220-240 V
<b>Electrical connection rating</b>	240 W	<b>Frequency (Hz)</b>	50 Hz
<b>Current</b>	1.4 A	<b>Power supply cable length</b>	250 cm

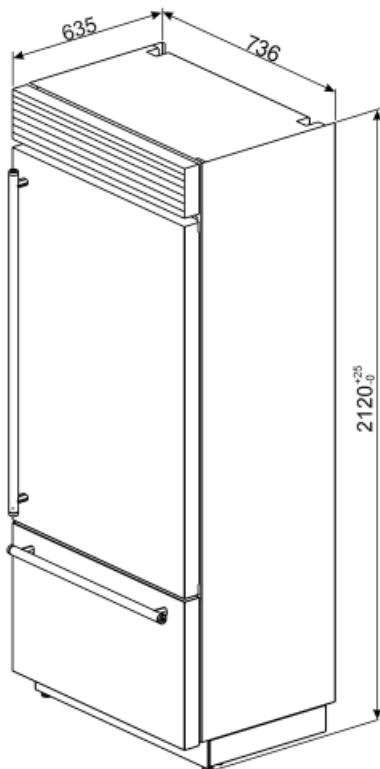

## Not included accessories

---





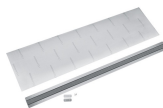











**REFLK6075**  
Connecting Kit



**REFLKA1**  
Connecting Kit

## Symbols glossary (TT)

 <p>4 stars freezing compartment for better food preservation.</p>	 <p>The automatic defrost system works by automatically defrosting at regular intervals eliminating the need to defrost altogether.</p>
 <p>A+: Energy efficiency class A+ helps to save up to 10% energy compared to class A. Maximum performance with minimum consumption is guaranteed.</p>	 <p>Child lock: some models are fitted with a device to lock the programme/cycle so it cannot be accidentally changed.</p>
 <p>LCD display: to optimize performance and simplify the use of the appliance.</p>	 <p>Fast freezing: The fast freezing function brings the temperature of the compartment down when activated a few hours prior to usage.</p>
 <p>Power saving mode: The power saving mode allows you to disable the refrigerator and keep the freezer working.</p>	 <p>LED interior lighting: is a more energy efficient and long lasting way of illuminating the interior of the appliance.</p>
 <p>Life Plus 0°C: The temperature in the Lifeplus compartments is kept at 0°C, which preserves fresh meat and fish longer.</p>	 <p>Smeg's evolution towards more intelligent and eco-friendly models has led to the choice of Inverter technology, which significantly reduces consumption.</p>
 <p>Air plus: keeps food fresher for longer.</p>	 <p>Multizone: Multizone compartment can be used as a refrigerator or a freezer compartment. Depending on your needs and eating habits, you can select settings, program the temperature using.</p>
 <p>No Frost: The No Frost and Frost free systems prevent ice from forming so that no defrosting is required.</p>	 <p>Energy efficiency class F</p>