

TR93BL

| | |
|--|-------------------|
| Cooker size | 90x60 cm |
| N. of cavities with energy label | 2 |
| Cavity heat source | ELECTRICITY |
| Hob type | Gas |
| Type of main oven | Thermo-ventilated |
| Type of second oven | Thermo-ventilated |
| Cleaning system main oven | Vapor Clean |
| EAN code | 8017709182458 |
| Energy efficiency class | A |
| Energy efficiency class, second cavity | B |



Aesthetics



| | | | |
|-----------------------------|-----------------|--------------------------|-------------------------|
| Aesthetic | Victoria | Display | electronic 5 buttons |
| Colour | Black | Colour of buttons | Black |
| Design | Victoria | No. of controls | 10 |
| Door | With frame | Serigraphy colour | Silver |
| Upstand | Yes | Handle | Smeg Victoria |
| Type of pan stands | Cast Iron | Handle Colour | Brushed stainless steel |
| Hob colour | Black enamel | Glass type | Black |
| Command panel finish | Enamelled metal | Plinth | Anthracite |
| Control knobs | Smeg Victoria | Logo | assembled 50's |
| Controls colour | Stainless steel | Logo position | Upstand+ Command panel |

Programme / Functions

No. of cooking functions 5

Traditional cooking functions



Static



Fan assisted



Circulaire



Eco



Fan assisted bottom

Cleaning functions



Vapor clean

Other functions

 Defrost by time

Programs / Functions Auxiliary Oven

Cooking functions cavity 2 1
 Traditional cooking functions, cavity 2

 Circulaire

Programs / Functions Third Oven

No. of functions third oven 1

Oven light 

Full grill 

Hob technical features

UR

Total no. of cook zones 6

Front left - Gas - 2UR (dual) - 4.20 kW

Rear left - Gas - AUX - 1.00 kW

Front centre - Gas - AUX - 1.00 kW

Rear centre - Gas - Semi Rapid - 1.80 kW

Front right - Gas - Semi Rapid - 1.80 kW

Rear right - Gas - Rapid - 2.90 kW

Type of gas burners Standard

Gas safety valves Yes

Automatic electronic ignition Yes

Burner caps Matt black enamelled

Main Oven Technical Features



No. of lights 1

Fan number 1

Net volume of the cavity 61 l

Gross volume, 1st cavity 70 l

Cavity material Ever Clean enamel

No. of shelves 4

Type of shelves Metal racks

Light type Halogen

Light Power 40 W

Cooking time setting Start and Stop

Door opening Side opening

Removable inner door Yes

Total no. of door glasses 3

No. of thermo-reflective door glasses 1

Safety Thermostat Yes

Cooling system Tangential

Usable cavity space dimensions (HxWxD) 316x460x412 mm

Temperature control Electro-mechanical

Lower heating element power 1200 W

| | | | |
|-----------------------|-----|----------------------------------|----------|
| Side opening door | Yes | Upper heating element - Power | 1000 W |
| Removable door | Yes | Grill element | 1700 W |
| Full glass inner door | Yes | Large grill - Power | 2700 W |
| | | Circular heating element - Power | 2000 W |
| | | Grill type | Electric |
| | | Tilting grill | Yes |

Options Main Oven

| | | | |
|-------------------------------|-----|---------------------|--------|
| Timer | Yes | Minimum Temperature | 50 °C |
| End of cooking acoustic alarm | Yes | Maximum temperature | 260 °C |

Second Oven Technical Features



| | | | |
|---------------------------------|-------------------|--|--------------------|
| Net volume of the second cavity | 62 l | Removable door | Yes |
| Gross volume, 2nd cavity | 69 l | Full glass inner door | Yes |
| Cavity material | Ever Clean enamel | Removable inner door | Yes |
| No. of shelves | 9 | No. total door glasses | 2 |
| Type of shelves | Metal racks | No. thermo-reflective door glasses | 1 |
| No. of lights | 1 | Safety Thermostat | Yes |
| Light type | Halogen | Cooling system | Tangential |
| Light Power | 40 W | Usable cavity space dimensions (HxWxD) | 605x275x370 mm |
| Door opening | Side opening | Temperature control | Electro-mechanical |
| Side opening door | Yes | Circular heating element - Power | 2500 W |

Options Auxiliary Oven

| | | | |
|---------------------|-------|---------------------|--------|
| Minimum Temperature | 50 °C | Maximum temperature | 245 °C |
|---------------------|-------|---------------------|--------|

Third Oven Technical Features



| | | | |
|--------------------------|-------------------|--|--------------------|
| Net volume, 3rd cavity | 36 l | Removable inner door | Yes |
| Gross volume, 3rd cavity | 41 l | No. total door glasses | 3 |
| Cavity material | Ever Clean enamel | No. of thermo-reflective door glasses | 1 |
| No. of shelves | 2 | Safety Thermostat | Yes |
| Type of shelves | Metal racks | Cooling system | Tangential |
| No. of lights | 1 | Usable cavity space dimensions (HxWxD) | 169x440x443 mm |
| Light type | Halogen | Temperature control | Electro-mechanical |
| Light Power | 40 W | | |

| | | | |
|-----------------------|-----------|---------------------|----------|
| Door opening | Flap down | Large grill - Power | 2700 W |
| Removable door | Yes | Grill type | Electric |
| Full glass inner door | Yes | Tilting grill | Yes |

Options Third Oven

| | | | |
|---------------------|-------|---------------------|--------|
| Minimum Temperature | 50 °C | Maximum temperature | 260 °C |
|---------------------|-------|---------------------|--------|

Accessories included for Main Oven & Hob



| | | | |
|------------------------------|---|--|---|
| Cast iron wok support | 1 | 40mm deep tray | 1 |
| Moka stand in cast iron | 1 | Grill mesh | 1 |
| Rack with back and side stop | 2 | Telescopic Guide rails, partial Extraction | 1 |

Accessories included for Secondary Oven



| | | | |
|--------------------------|---|-------------------|---|
| Oven grid with back stop | 4 | Plate rack/warmer | 1 |
|--------------------------|---|-------------------|---|

Accessories included for Third Oven

| | | | |
|------------------------------|---|----------------|---|
| Rack with back and side stop | 1 | 40mm deep tray | 1 |
|------------------------------|---|----------------|---|

Electrical Connection

| | | | |
|------------------------------|-----------|----------------------------------|-----------------------------|
| Electrical connection rating | 8300 W | Type of electric cable installed | Yes, Single phase |
| Current | 36 A | Additional connection modalities | Yes, Double and Three Phase |
| Voltage | 220-240 V | Frequency | 50/60 Hz |
| Voltage 2 (V) | 380-415 V | Terminal block | 5 poles |

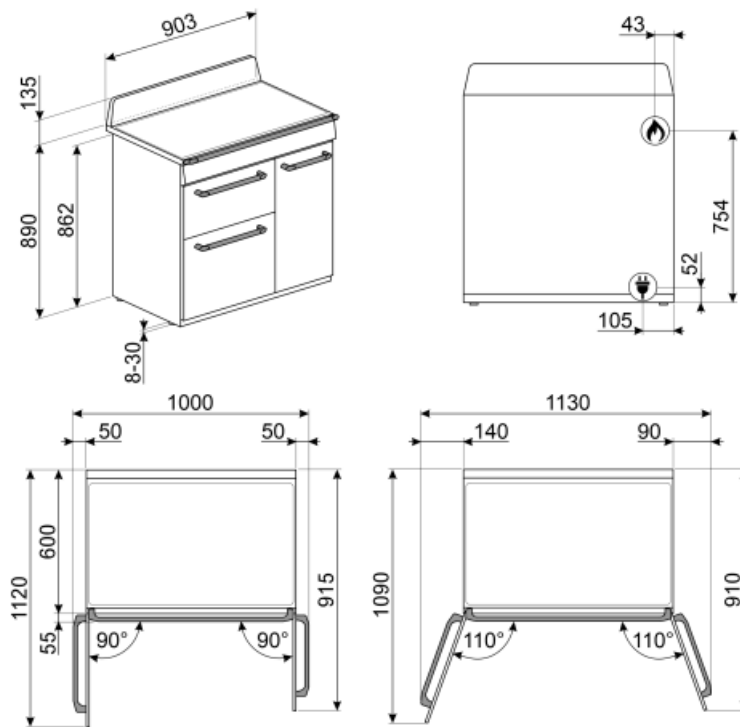

Not included accessories



TPKTR9

Stainless steel teppanyaki plate, suitable for Victoria TR9, Master and Sinfonia cookers



SFLK1

Child lock



PRTX

Refractory pizza stone with handles. D=35cm Not suitable for microwave ovens. Suitable for gas ovens, to be put on the griddle.



BGTR9

Cast iron grill plate suitable for 90 cm Victoria, 60 and 90 cm Master and Sinfonia cookers



BN620-1

Enamelled tray suitable for 45cm and 60cm ovens. Depth 20 mm. Perfect for a wide range of savoury and sweet baking.



GT1P-2

Partially extractable telescopic guides (1 level) for ovens with metal frames. Length: 355.5 mm, extraction: 285 mm. Material: Stainless steel AISI 430 polished.



PALPZ

Pizza shovel with folding handle. Dimensions L31.5 x H32.5 cm. Easy and convenient to use and store. Perfect for serving pizza, bread and savory pastries in a safe and professional way.



BN640

Enamelled tray suitable for 45cm and 60cm ovens. Depth 540 mm. Perfect for cooking and roasting meat and fish in sauces. Also ideal for experimenting with lighter and crunchy side dishes



AIRFRY

Air fryer rack AIRFRY . Ideal for recreating traditional frying in the oven, but with fewer calories and less fat. It allows you to cook quickly and simply dishes such as French fries, fried vegetables and fish, ensuring perfect browning and crispiness.



GTP

Partially extractable telescopic guides (1 level), suitable for traditional ovens. Made in stainless steel, they guarantee stability and facilitate the smooth extraction of the trays.



BNP608T

Teflon-coated tray, 8mm depth, to be placed on the grid



KIT1TR9N

Splashback black, 90cm ,suitable for TR90 and TR93 Victoria cookers



KITH93

Height extension kit (950mm), black, suitable for TR93 cookers (945-960mm)



BBQ

Double sided plate BBQ. Suitable for recreating succulent and crispy dishes in the oven with the typical taste of grilled cooking. The ribbed side is particularly suitable for meats and cheeses. The smooth side for fish, seafood and vegetables.



GTT



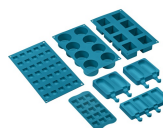















Totally extractable telescopic guides (1 level), suitable for traditional ovens. Made in stainless steel, they guarantee stability and facilitate the smooth extraction of the trays.















SMOLD

Set of 7 silicone moulds for ice creams, ice lollies, pralines, ice cubes or to portion food. Usable from -60°C to +230°C

Symbols glossary (TT)

| | |
|--|--|
|  <p>A: Product drying performance, measured from A+++ to D / G depending on the product family</p> |  <p>A-10%: Product energy rating, measured from A+++ to D / G depending on the product family.</p> |
|  <p>B: Product energy rating, measured from A+++ to D / G depending on the product family.</p> |  <p>Heavy duty cast iron pan stands: for maximum stability and strength.</p> |
|  <p>Air cooling system: to ensure a safe surface temperatures.</p> |  <p>Defrost by time: Manual defrost function. At the end of the set duration, the function stops.</p> |
|  <p>Double glazed doors: Number of glazed doors.</p> |  <p>Triple glazed doors: Number of glazed doors.</p> |
|  <p>Ever Clean Enamel: Ever Clean enamel is applied electrostatically, corner to corner and edge to edge to prevent cracking or cracks over time. It is a particular pyrolytic enamel, resistant to acids which, in addition to being pleasantly bright, promotes greater cleaning of the oven walls, thanks to its lower porosity. It is baked at over 850 ° C and slowly polymerized at a scientifically determined rate to ensure uniform depth and strength Ever Clean enamel creates an impeccable finish both on the inside of the oven and on the trays, making the surfaces of the oven incredibly easy to maintain over time as it reduces the adhesion of fat during cooking</p> |  <p>Fan assisted base: the mix of fan and lower heating element alone allows to finish cooking foods already cooked on the surface but not internally more quickly. This system is recommended to finish cooking foods that are already well cooked on the surface, but not internally, which therefore require a moderate higher heat. Ideal for any type of food.</p> |
|  <p>Fan assisted: Intense and homogeneous traditional cooking, also suitable for complex recipes. The fan is active and the heat comes from below and from above at the same time. Ventilated cooking ensures a faster and more homogeneous result, leaving fragrant foods outside and moister inside. Ideal for baked pasta, biscuits, roasts and cobblers.</p> |  <p>Static: Traditional cooking suitable for the preparation of one dish at a time. The fan is not active and the heat comes from below and from above at the same time. Static cooking is slower and more delicate, ideal in order to get well cooked and dry dishes even inside. Ideal for cooking all types of roasts, fatty meats, bread, filled cakes.</p> |
|  <p>Circulaire: it is the perfect function for cooking all types of dishes in a more delicate way. The heat comes from the back of the oven and is distributed quickly and evenly The fan is active. It is also ideal for cooking on multiple levels without mixing smells and flavors.</p> |  <p>ECO: low energy consumption cooking: this function is particularly suitable for cooking on a single shelf with low energy consumption. It is recommended for all types of food except those that can generate a lot of moisture (for example vegetables). To achieve maximum energy savings and reduce time, it is recommended to put the food in the oven without preheating the cooking compartment</p> |
|  <p>Grill element: Using of grill gives excellent results when cooking meat of medium and small portions, especially when combined with a rotisserie (where possible). Also ideal for cooking sausages and bacon.</p> |  <p>Light</p> |
|  <p>All glass inner door: All glass inner door, a single flat surface which is simple to keep clean.</p> |  <p>The inner door glass: can be removed with a few quick movements for cleaning.</p> |

-
- | | | | |
|---|--|---|---|
|  | Side lights: Two opposing side lights increase visibility inside the oven. |  | Plate rack warming: function for heating or keeping dishes warm. Place the baking tray on the lowest shelf and stack the dishes to be heated. |
|  | The oven cavity has 2 different cooking levels. |  | The oven cavity has 4 different cooking levels. |
|  | The oven cavity has 9 different cooking levels. |  | Telescopic rails: allow you to pull out the dish and check it without having to remove it from the oven entirely. |
|  | Electronic control: Allows you to maintain temperature inside the oven with the precision 2-3 ° C. This enables to cook meals that are very sensitive to temperature changes, such as cakes, souffles, puddings. |  | Tilting grill: the tilting grill can be easily unhooked to move the heating element and clean the roof of the appliance in one simple step. |
|  | Ultra rapid burners: Powerful ultra rapid burners offer up to 5kw of power. |  | Vapor Clean: a simple cleaning function using steam to loosen deposits in the oven cavity. |
|  | The capacity indicates the amount of usable space in the oven cavity in litres. |  | The capacity indicates the amount of usable space in the oven cavity in litres. |
|  | The capacity indicates the amount of usable space in the oven cavity in litres. | | |