

P875AO

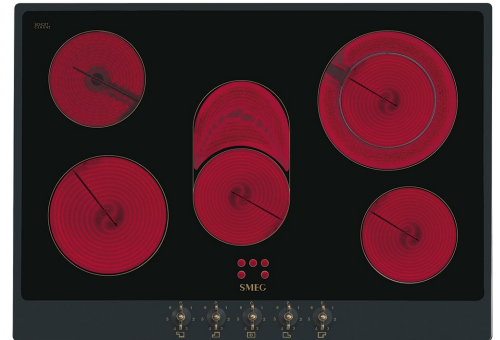

Product Family	Hob
Built-in type	Traditional
Dimensions	70/75 cm
Power supply	Electric
Type	Ceramic
EAN code	8017709259990



Aesthetics



Aesthetic	Coloniale
Colour	Anthracite
Material	Verniciato
Frame	Yes
Frame colour	Anthracite
Type of control setting	Control knobs
Control knob position	Front
No. of controls	5
Controls colour	Antique brass
Components finishing	Antique brass
Serigraphy colour	Gold
Alternative colours available	Cream

Programme / Functions

Total no. of cook zones	5
No. of ceramic cook zones	5
Power levels	6

Options

Worktop Cut-Out	490x685 mm
-----------------	------------

Technical Features

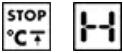

Front-left - Ceramic - Single - 1.80 kW - Ø 18.0 cm
 Rear-left - Ceramic - Single - 1.20 kW - Ø 14.0 cm
 Central - Ceramic - Single - 2.00 kW - 15.0x25.0 cm
 Rear-right - Ceramic - Single - 2.40 kW - Ø 21.0 cm
 Front-right - Ceramic - Single - 1.20 kW - Ø 14.0 cm

Minimum pan diameter indication Yes

Residual heat indicator Yes

Automatic switch off when overheat Yes

Electrical Connection

Electrical connection rating (W)	8600 W	Additional connection modalities	Yes, Single and Double phase
Current	24 A	Frequency (Hz)	50/60 Hz
Voltage (V)	220-240 V	Power supply cable length	150 cm
Voltage 2 (V)	380-415 V	Terminal box	6 poles
Type of electric cable installed	Yes, Three-phase		

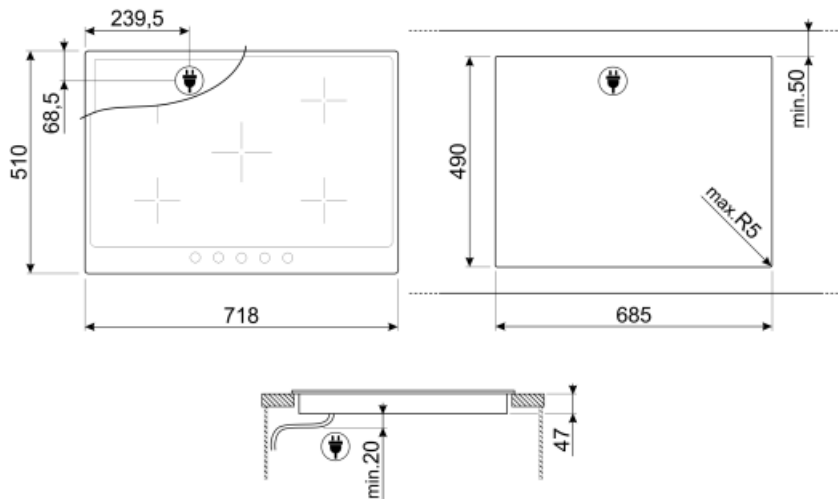

Not included accessories

5MP800A

Hob knobs set - Coloniale
Gold/Anthracite for gas on glass hobs



5MP800P

Hob knobs set - Coloniale Gold/Cream
for gas on glass hobs



5MP700PO

Hob knobs set - Cortina Cream/Old
brass for Gas on Glass hobs



5MP700AO

Hob knobs set - Cortina
Anthracite/Old brass for Gas on Glass
hobs







SCRP

Non-scratch hob scraper - suitable for
induction and ceramic hobs



Symbols glossary (TT)

- | | | | |
|--|---|---|--|
|  | Standard installation: Traditional installation in tabletop, suitable for any kitchen sets |  | Knobs control |
|  | Overheat protection: The safety system that automatically turns off the hob in case of overheating of the control unit. |  | Glass ceramic: The base of the hob is made glass ceramic. Heating is performed by the heating elements Hi-Light. |
|  | Indication of residual heat: After the glass ceramic hob is switched off the residual heat indicator shows which of the heating zones still remains hot. When the temperature drops below 60 ° C, the indicator goes out. | | |