

FQ60XDAIF



Product Family	Refrigerator
Installation	Free standing
Category	4 Doors
Reference width	Higher than 80
Sistema Total No - Frost	Total
Cooling type	Total No Frost - Triple Cooling system
Defrost	Automatic
Hinge type	Standard
EAN code	8017709293314



Aesthetics



Aesthetic	Universale	Logo colour	Chrome
Colour	Inox-look	Side material	Steel
Finishing	Fingerproof	Side colour	Silver
Design	Flat	Logo	Applied
Material	Steel Effect	Door shelves profile color	Silver
Door steel type	Finger proof	Drawers profile color	Silver
Handle	External	Color of glass shelf profile	Silver
Handle type	Fixed	Display	LED
Handle colour	Stainless steel	Display position	Esterno (su porta)

Refrigerator compartment features



No. of adjustable shelves	2	Type of crisper/vegetable drawers cover	Glass
Number of fruit and vegetables drawers	2	Life Plus zone-0°C	Yes
Type of adjustable shelves	Glass	Internal light in fridge	Yes
Type of crisper/vegetable drawers cover	On sliding rails	Type of internal light (fridge)	LED
Crisper Cover	Yes		

Refrigerator Inner Door

No. of door shelves with transparent cover	2	No. of bottle shelves	2
Number of adjustable door shelves	2		

Other Refrigerator features



Accessories	Egg tray	Fan	Yes
Natural Plus Blu Light	Yes	Ionizer	Yes
MultiFlow	Yes	Antibacterial odour filter	Yes

Freezer compartment features

Number of drawers	3	Type of internal light (freezer)	LED
No. of shelves	2	Type of shelves	Glass
Internal light in freezer	Yes		

Freezer Inner Door

No. of adjustable door shelves	2
--------------------------------	---

Other Freezer features



Ice maker	Automatic	Fast freezing compartment	Yes
-----------	-----------	---------------------------	-----

Other technical features

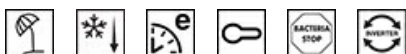

Functions display	Holiday, Fast freezing, Fast cooling, ECO, Control lock
MultiZone	Yes
Fast freezing button	Yes
Temperature alarm lamp	Yes
Door open alarm	Acoustic and visual
Temperature Alarm	Acoustic and visual
Antibacterial Gasket	Yes
Type of temperature control	Electronic
No. of compressors	1

Refrigerant gas type	R600a
Type of compressor	Inverter
Refrigerant Quantity (gr)	77 g
Foam agent	Cyclopentane

Performance / Energy Label NEW 2019







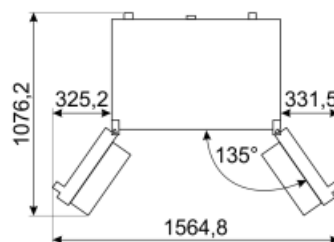
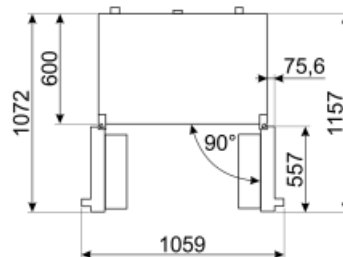
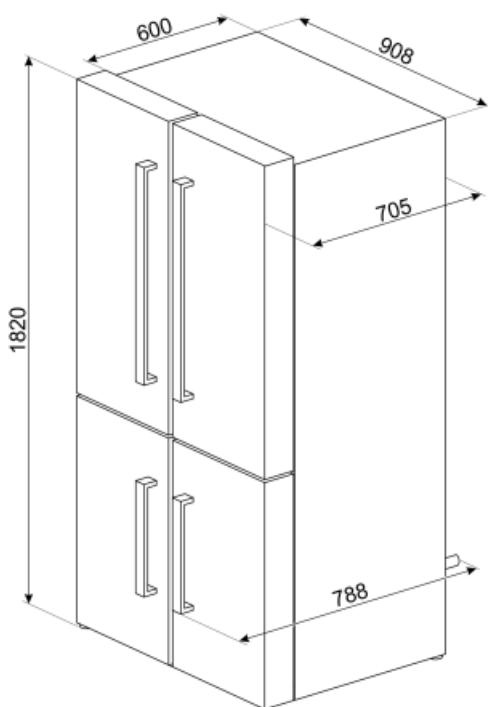











			
Annual energy consumption	414 kWh/a	Airborne acoustical noise emissions	39 dB(A) re 1pW
Energy efficiency class	F	Temperature Rise Time	10 h
Airborne acoustical noise emission class	C	4 star - Freezing capacity	4.6 Kg/24h
Total net volume	572 l	Climate class	SN, T
Sum of the volumes of the frozen compartment(s)	196 l	EEl	125 %
Sum of the volumes of the chill compartment(s) and the unfrozen compartment(s)	376 l		

Electrical Connection

Plug	(F;E) Schuko	Voltage (V)	230 V
Electrical connection rating	200 W	Frequency (Hz)	50 Hz
Current	0.8 A	Power supply cable length	240 cm



Symbols glossary (TT)

 <p>4 stars freezing compartment for better food preservation.</p>	 <p>Smeg Active Ion system improves the quality of the air inside the cell. Thanks to the generation of negatively charged ions released inside the fridge Active Ion system neutralizes unpleasant dust.</p>
 <p>The automatic defrost system works by automatically defrosting at regular intervals eliminating the need to defrost altogether.</p>	 <p>Antibacterial treatment: antibacterial treatment to ensure better hygiene</p>
 <p>Child lock: some models are fitted with a device to lock the programme/cycle so it cannot be accidentally changed.</p>	 <p>LED display: to show programmes, functions and options selected and the time to the end of the cycle.</p>
 <p>Economical mode: Analyzes fridge functioning during the activation and optimizes the operating cycle in order to reduce power consumption.</p>	 <p>Energy efficiency class F</p>
 <p>A++: Energy efficiency class A++ helps to save up to 20% energy compared to class A. Maximum performance with minimum consumption is guaranteed.</p>	 <p>Ventilated: Forced distribution of cold air in the refrigerator compartment, which allows even temperature distribution within the fridge.</p>
 <p>Fast freezing: The fast freezing function brings the temperature of the compartment down when activated a few hours prior to usage.</p>	 <p>Fingerprint proof stainless steel: Fingerprint proof stainless steel keeps stainless steel looking as good as new.</p>
 <p>Power saving mode: The power saving mode allows you to disable the refrigerator and keep the freezer working.</p>	 <p>LED interior lighting: is a more energy efficient and long lasting way of illuminating the interior of the appliance.</p>
 <p>Life Plus 0°C: The temperature in the Lifeplus compartments is kept at 0°C, which preserves fresh meat and fish longer.</p>	 <p>Smeg's evolution towards more intelligent and eco-friendly models has led to the choice of Inverter technology, which significantly reduces consumption.</p>
 <p>Air plus: keeps food fresher for longer.</p>	 <p>Natural Plus Blu Light: This unique Natural Plus Blu Light system works with nature to increase the storage time of fruit and vegetables.</p>