

FQ60CA05



Product Family	Refrigerator
Installation	Free standing
Category	4 Doors
Reference width	Higher than 80
Sistema Total No - Frost	Total
Cooling type	Total No Frost - Double Cooling system
Defrost	Automatic
EAN code	8017709297503



Aesthetics



Aesthetic	Coloniale	Side material	Steel
Colour	Anthracite	Side colour	Dark grey
Design	Flat	Logo	Applied
Material	Metal sheet	Door shelves profile color	Silver
Handle kit to be ordered separately	Yes	Drawers profile color	Silver
Handle	External	Color of glass shelf profile	Chrome
Handle type	Fixed	Display	LED
Handle colour	Antique brass	Display position	Interno (sul Top)
Logo colour	Antique brass		

Refrigerator compartment features



No. of adjustable shelves	2	Type of crisper/vegetable drawers cover	Glass
Number of fruit and vegetables drawers	2	Life Plus zone-0°C	Yes
Type of adjustable shelves	Glass	Internal light in fridge	Yes
Type of crisper/vegetable drawers cover	Standard	Type of internal light (fridge)	LED
Crisper Cover	Yes		

Refrigerator Inner Door

No. of door shelves with transparent cover 2
 Number of adjustable door shelves 2

No. of bottle shelves 2

Other Refrigerator features



Accessories Egg tray
 Natural Plus Blu Light Yes
 MultiFlow Yes

Fan Ionizer Yes
 Yes

Freezer compartment features

Number of drawers 3
 No. of shelves 2

Type of shelves Glass

Other Freezer features



Manual ice maker Yes

Fast freezing compartment Yes

Other technical features



Functions display Fast freezing, Fast cooling
 Fast freezing button Yes
 Door open alarm Yes
 Type of temperature control Electronic
 No. of compressors 1
 Refrigerant gas type R600a
 Type of compressor Inverter
 Refrigerant Quantity (gr) 72 g
 Foam agent Cyclopentane

Performance / Energy Label NEW 2019



Annual energy consumption 415 kWh/a
 Energy efficiency class F
 Airborne acoustical noise emission class C
 Total net volume 581 l
 Airborne acoustical noise emissions 39 dB(A) re 1pW
 Temperature Rise Time 10 h
 4 star - Freezing capacity 4.6 Kg/24h

Sum of the volumes of the frozen compartment(s) 196 l
Sum of the volumes of the chill compartment(s) and the unfrozen compartment(s) 385 l

4 star - Freezing capacity 1
Climate class EEI

4.6 Kg/24h
SN, N, ST, T
124 %

Electrical Connection

Plug (F;E) Schuko
Electrical connection rating 200 W
Current 0,8 A

Voltage (V) 220-240 V
Frequency (Hz) 50 Hz
Power supply cable length 240 cm

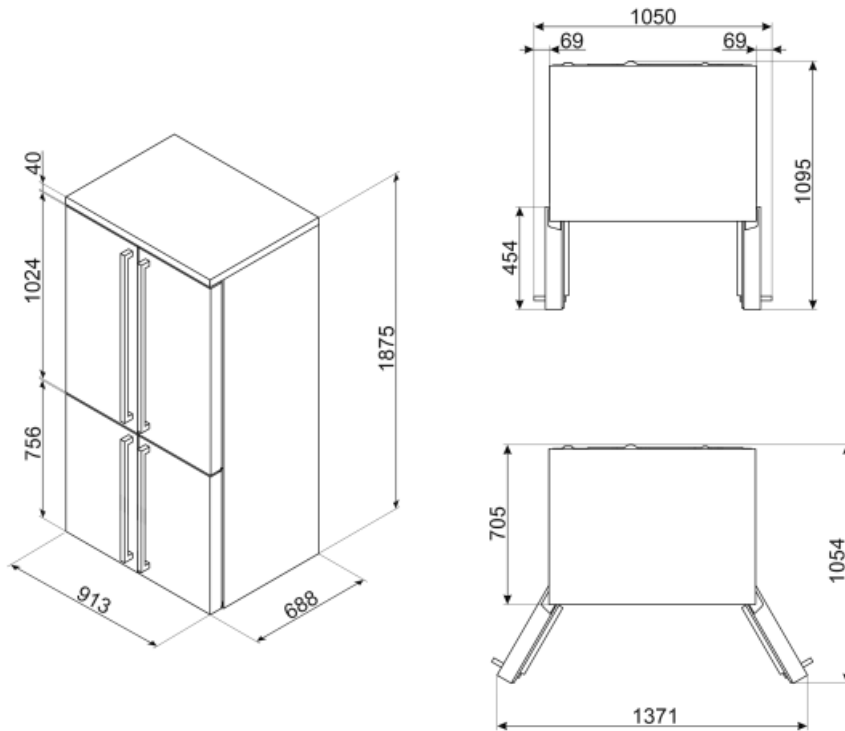

Not included accessories













KMOFQ7-1



KMOFQ8-1



Symbols glossary (TT)

 <p>4 stars freezing compartment for better food preservation.</p>	 <p>Smeg Active Ion system improves the quality of the air inside the cell. Thanks to the generation of negatively charged ions released inside the fridge Active Ion system neutralizes unpleasant dust.</p>
 <p>The automatic defrost system works by automatically defrosting at regular intervals eliminating the need to defrost altogether.</p>	 <p>LED display: to show programmes, functions and options selected and the time to the end of the cycle.</p>
 <p>Energy efficiency class F</p>	 <p>A+: Energy efficiency class A+ helps to save up to 10% energy compared to class A. Maximum performance with minimum consumption is guaranteed.</p>
 <p>Ventilated: Forced distribution of cold air in the refrigerator compartment, which allows even temperature distribution within the fridge.</p>	 <p>Fast freezing: The fast freezing function brings the temperature of the compartment down when activated a few hours prior to usage.</p>
 <p>LED interior lighting: is a more energy efficient and long lasting way of illuminating the interior of the appliance.</p>	 <p>Life Plus 0°C: The temperature in the Lifeplus compartments is kept at 0°C, which preserves fresh meat and fish longer.</p>
 <p>Smeg's evolution towards more intelligent and eco-friendly models has led to the choice of Inverter technology, which significantly reduces consumption.</p>	 <p>Air plus: keeps food fresher for longer.</p>
 <p>Natural Plus Blu Light: This unique Natural Plus Blu Light system works with nature to increase the storage time of fruit and vegetables.</p>	