

FQ60BDF



| | |
|--------------------------|--|
| Product Family | Refrigerator |
| Installation | Free standing |
| Category | 4 Doors |
| Reference width | Higher than 80 |
| Sistema Total No - Frost | Total |
| Cooling type | Total No Frost - Double Cooling system |
| Defrost | Automatic |
| Hinge type | Standard |
| EAN code | 8017709293338 |



Aesthetics



| | | | |
|---------------|-------------|-------------------------------|------------------------|
| Aesthetic | Universale | Side colour | White |
| Colour | White | Logo | Applied |
| Design | Flat | Door shelves profile color | Silver |
| Material | Metal sheet | Drawers profile color | Silver |
| Handle | External | Color of glass shelf profile | Silver |
| Handle type | Fixed | Display | LED |
| Handle colour | Silver | Display position | Esterno (su porta) |
| Logo colour | Chrome | Alternative colours available | Stainless steel, Black |
| Side material | Steel | | |

Refrigerator compartment features



| | | | |
|---|------------------|---|-------|
| No. of adjustable shelves | 2 | Type of crisper/vegetable drawers cover | Glass |
| Number of fruit and vegetables drawers | 2 | Life Plus zone-0°C | Yes |
| Type of adjustable shelves | Glass | Internal light in fridge | Yes |
| Type of crisper/vegetable drawers cover | On sliding rails | Type of internal light (fridge) | LED |
| Crisper Cover | Yes | | |

Refrigerator Inner Door

| | | | |
|--|---|-----------------------|---|
| No. of door shelves with transparent cover | 2 | No. of bottle shelves | 2 |
| Number of adjustable door shelves | 2 | | |

Other Refrigerator features



| | | | |
|------------------------|----------|----------------------------|-----|
| Accessories | Egg tray | Fan | Yes |
| Natural Plus Blu Light | Yes | Ionizer | Yes |
| MultiFlow | Yes | Antibacterial odour filter | Yes |

Freezer compartment features

| | | | |
|---------------------------|-----|----------------------------------|-------|
| Number of drawers | 3 | Type of internal light (freezer) | LED |
| No. of shelves | 2 | Type of shelves | Glass |
| Internal light in freezer | Yes | | |

Other Freezer features



| | | | |
|------------------|--------|---------------------------|-----|
| Manual ice maker | Yes | Fast freezing compartment | Yes |
| Ice maker | Manual | | |

Other technical features

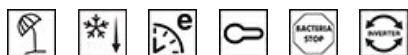

| | |
|-----------------------------|---|
| Functions display | Holiday, Fast freezing, Fast cooling, ECO, Control lock |
| Fast freezing button | Yes |
| Temperature alarm lamp | Yes |
| Door open alarm | Yes |
| Temperature Alarm | Yes |
| Antibacterial Gasket | Yes |
| Type of temperature control | Electronic |
| No. of compressors | 1 |
| Refrigerant gas type | R600a |
| Type of compressor | Inverter |
| Refrigerant Quantity (gr) | 72 g |
| Foam agent | Cyclopentane |

Performance / Energy Label NEW 2019









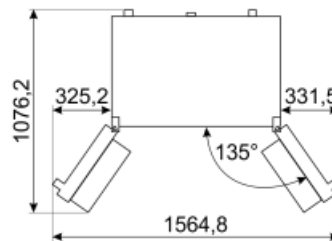
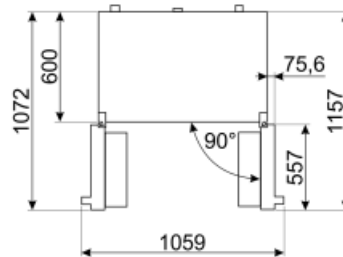
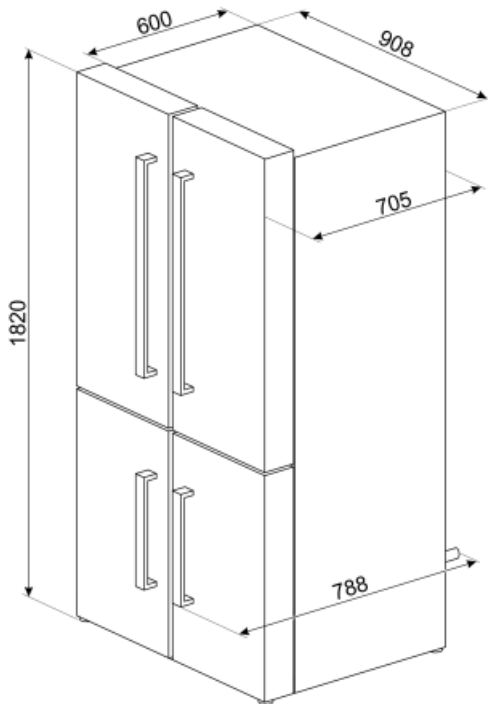









| | | | |
|---|-----------|--|-----------------|
| Annual energy consumption | 406 kWh/a | Airborne acoustical noise emissions | 39 dB(A) re 1pW |
| Energy efficiency class | F | Temperature Rise Time | 10 h |
| Airborne acoustical noise emission class | C | 4 star - Freezing capacity | 4.6 Kg/24h |
| Total net volume | 572 l | 4 star - Freezing capacity 1 | 4.6 Kg/24h |
| Sum of the volumes of the frozen compartment(s) | 196 l | Climate class | SN, T |
| Sum of the volumes of the chill compartment(s) and the unfrozen compartment(s) | 376 l | EEl | 125 % |

Electrical Connection

| | | | |
|-------------------------------------|--------------|----------------------------------|--------|
| Plug | (F;E) Schuko | Voltage (V) | 230 V |
| Electrical connection rating | 200 W | Frequency (Hz) | 50 Hz |
| Current | 0.8 A | Power supply cable length | 240 cm |



Symbols glossary (TT)

| | |
|--|--|
|  <p>4 stars freezing compartment for better food preservation.</p> |  <p>Smeg Active Ion system improves the quality of the air inside the cell. Thanks to the generation of negatively charged ions released inside the fridge Active Ion system neutralizes unpleasant dust.</p> |
|  <p>The automatic defrost system works by automatically defrosting at regular intervals eliminating the need to defrost altogether.</p> |  <p>Antibacterial treatment: antibacterial treatment to ensure better hygiene</p> |
|  <p>Child lock: some models are fitted with a device to lock the programme/cycle so it cannot be accidentally changed.</p> |  <p>LED display: to show programmes, functions and options selected and the time to the end of the cycle.</p> |
|  <p>Economical mode: Analyzes fridge functioning during the activation and optimizes the operating cycle in order to reduce power consumption.</p> |  <p>Energy efficiency class F</p> |
|  <p>A+: Energy efficiency class A+ helps to save up to 10% energy compared to class A. Maximum performance with minimum consumption is guaranteed.</p> |  <p>Ventilated: Forced distribution of cold air in the refrigerator compartment, which allows even temperature distribution within the fridge.</p> |
|  <p>Fast freezing: The fast freezing function brings the temperature of the compartment down when activated a few hours prior to usage.</p> |  <p>Power saving mode: The power saving mode allows you to disable the refrigerator and keep the freezer working.</p> |
|  <p>LED interior lighting: is a more energy efficient and long lasting way of illuminating the interior of the appliance.</p> |  <p>Life Plus 0°C: The temperature in the Lifeplus compartments is kept at 0°C, which preserves fresh meat and fish longer.</p> |
|  <p>Smeg's evolution towards more intelligent and eco-friendly models has led to the choice of Inverter technology, which significantly reduces consumption.</p> |  <p>Air plus: keeps food fresher for longer.</p> |
|  <p>Natural Plus Blu Light: This unique Natural Plus Blu Light system works with nature to increase the storage time of fruit and vegetables.</p> | |