

SIA1963D

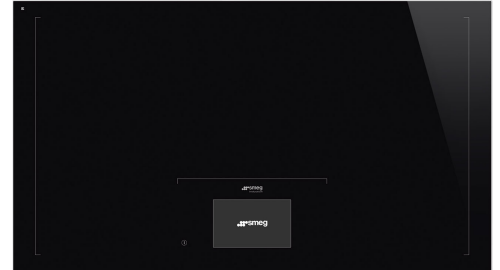

Product Family	Hob
Built-in type	Ultra-low profile or Fully Flushed
Dimensions	90 cm
Power supply	Electric
Type	Induction
EAN code	8017709304034



Aesthetics



Aesthetic	Universale
Colour	Black
Finishing	Glass
Material	Glass
Glass type	'Glassy' ceramic
Glass edge	Straight edge
Type of control setting	Vivo Screen Max
Slider	Yes
LED colours	TFT
Control knob position	Front
Serigraphy colour	Grey
Alternative colours available	Silver

Programme / Functions



No. of induction cook zones	6
Time-setting options	Spegnimento automatico
No. of cooking zones with booster	6
Main on/off switch	Yes
Power levels	17

Options



Multizone Option	Yes	Minute minder	1
Flexible Zone Type	AreaZone	End of cooking alarm	Yes
Worktop Cut-Out	500-916 mm	Residual time indicator	Yes
Auto Multizone	Yes	Limited Power	Si Advance
Auto-boiling Function	Yes	Consumption Mode	
Simmering Function	Yes	Limited Power	2400 a 11100 - step 100
Keep warm automatic function	Yes	Consumption Mode in W	W
Melting/Low temperature cooking function	Yes	Showroom Demo Option	Yes
End cooking timer	6	Control Lock / Child Safety	Yes
Pause option	Yes	Bridge option	Yes
		Quick start	Yes
		Rapid level selection	Yes

Technical Features



Central - Induction - Multizone - 2.40 kW - Booster 3.70 kW - 84.0x40.0 cm

Automatic setting according to pan dimension	Yes	Automatic switch off when overflow	Yes
pan detection	Si, min 10 cm	Residual heat indicator	Yes
Permanent Automatic Pot Detection with indication of the relative control	Yes	Protection against accidental start up	Yes
Automatic switch off when overheat	Yes		

Electrical Connection

Electrical connection rating (W)	11100 W	Additional connection modalities	Yes, Single and Double phase
Current	49 A	Type of electric cable supplied	Yes, Single and Double phase
Voltage (V)	220-240 V	Frequency (Hz)	50/60 Hz
Voltage 2 (V)	380-415 V	Power supply cable length	120 cm
Type of electric cable installed	Yes, Three-phase	Terminal box	5 poles

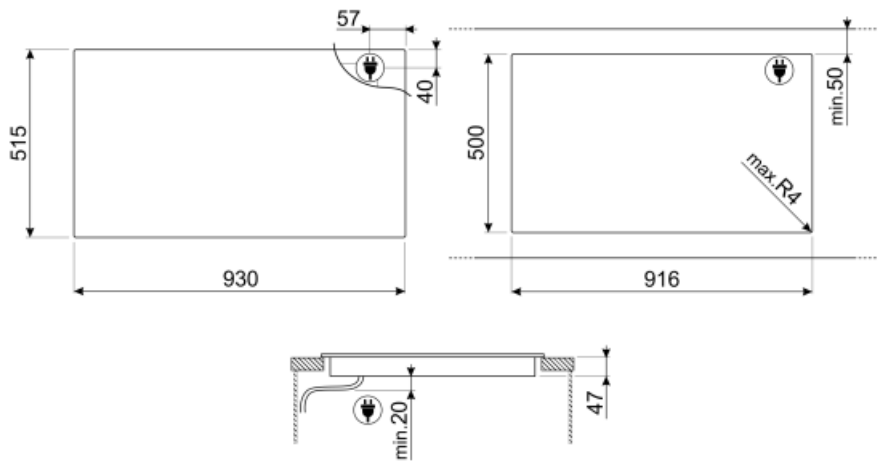

Not included accessories



GRILLPLATE

Universal griddle for induction, gas, ceramic and electric hobs. Non-stick surface ideal for cooking meat, cheese and vegetables. Dimensions: 410 x 240 mm.



TPK

Stainless steel grill plate to cook Teppanyaki dishes



SCRP























Non-scratch hob scraper - suitable for induction and ceramic hobs



TPKPLATE

Universal plate for induction, gas, ceramic and electric hobs. Non-stick surface ideal for cooking fish, eggs and vegetables. Dimensions: 410 X 240 mm.

Symbols glossary (TT)

	Automatic merge of zones for a bigger area		Permanent auto pot detection
	Automatic Boiling function: a sensor confirms once the boiling point has been reached and then an acoustic alert signals that the ingredients can be added, saving time and energy.		Power booster: option allows the zone to work at full power when very intense cooking is necessary.
	Child lock: some models are fitted with a device to lock the programme/cycle so it cannot be accidentally changed.		7 inches TFT touch, high resolution display, true colours
	The slider control panel allows you to adjust the power simply by passing your finger across the touch device.		This function allows you to keep cooked food warm without burner it
	Overheat protection: The safety system that automatically turns off the hob in case of overheating of the control unit.		Induction: The work of these hobs is based on the principle of electromagnetic induction. The heat is generated directly in the bottom of the pan during its contact with the hob.
	Melting function, suitable for slowly melting delicate foods such as chocolate or butter.		Overfill protection: The special overfill protection shuts down the stove in the presence of overflow of liquids.
	All cooking zones can be reduced to the minimum power level, so the hob can be left unattended for a short period without food overcooking or burning. Then just press again this function, the previously set power levels can be reactivated.		Quick selection, with one touch cooking begins at the highest level, then automatically reduces after time. Ideal for dishes that require quick boiling and then continued cooking without constant control (eg beef broth).
	Quick Start function: the chosen temperature is reached faster. The heating element works at maximum power until the right temperature is reached.		Indication of residual heat: After the glass ceramic hob is switched off the residual heat indicator shows which of the heating zones still remains hot. When the temperature drops below 60 ° C, the indicator goes out.
	Simmering function: ideal for long-cooking recipes, preventing food from boiling over or sticking to the pan.		Elegant silver or black glass with under glass serigraphy which allows smoothness, brilliance and no noise to the surface
	Time elapsed: shows how long the cooking zone has been in use.		Timer: All ceramic hobs have a timer which automatically ends cooking after a preset time.
	TWIN_ZONE_72dpi		Possibility to set the maximum power absorption of the hob