

A4-81

Cooker size	120x60 cm
N. of cavities with energy label	2
Cavity heat source	ELECTRICITY
Hob type	Gas
Type of main oven	Thermo-ventilated
Type of second oven	Fan assisted
Cleaning system main oven	Catalytic
EAN code	8017709256807
Energy efficiency class	A
Energy efficiency class, second cavity	A



Aesthetics



Aesthetic	Classica	Controls colour	Stainless steel
Serie	Opera	Display	Touch
Colour	Stainless steel	No. of controls	12
Finishing	Satin	Serigraphy colour	Black
Design	Professional	Handle	Smeg Classic
Door	With 2 horizontal strips	Handle Colour	Brushed stainless steel
Upstand	Yes	Glass type	Eclipse
Type of pan stands	Cast Iron	Storage compartment	Drawer
Hob colour	Stainless steel	Logo	Assembled st/steel
Command panel finish	Finger friendly stainless steel	Logo position	Facia below the oven
Control knobs	Smeg Classic		

Programme / Functions

No. of cooking functions 8

Traditional cooking functions



Static



Fan assisted



Circulaire



Eco



Small grill



Large grill



Fan grill (large)



Fan assisted bottom

Cleaning functions

Catalytic



Programs / Functions Auxiliary Oven

Cooking functions cavity 2 6

Traditional cooking functions, cavity 2



Static



Fan assisted



Large grill



Fan grill (large)



Fan-assisted bottom



Pizza

Cleaning functions cavity 2

Catalisi

Hob technical features



Total no. of cook zones 6

Front left - Gas - 2UR (dual) - 4.20 kW

Rear left - Gas - Semi Rapid - 1.80 kW

Front centre - Gas - AUX - 1.00 kW

Rear centre - Gas - Rapid - 3.00 kW

Front right - Gas - AUX - 1.00 kW

Rear right - Gas - Semi Rapid - 1.90 kW

Rear left - Gas - UR - 4.00 kW

Right - BBQ

Type of gas burners Standard

Burner caps Matt black enamelled

Automatic electronic ignition Yes

Automatic switch off when overflow Yes

Main Oven Technical Features



No. of lights	1
Fan number	1
Net volume of the cavity	61 l
Gross volume, 1st cavity	70 l
Cavity material	Ever Clean enamel
No. of shelves	4
Type of shelves	Metal racks
Light type	Halogen
Light Power	40 W
Cooking time setting	Contaminuti + fine cottura
Light when oven door is open	Yes
Door opening	Flap down
Removable door	Yes

Total no. of door glasses	3
No. of thermo-reflective door glasses	2
Safety Thermostat	Yes
Cooling system	Tangential
Usable cavity space dimensions (HxWxD)	316x460x412 mm
Temperature control	Electro-mechanical
Lower heating element power	1200 W
Upper heating element - Power	1000 W
Grill element	1700 W
Large grill - Power	2700 W

Full glass inner door Yes

Circular heating element 2000 W
- Power

Grill type Electric

Tilting grill Yes

Options Main Oven

Timer Yes

End of cooking acoustic alarm Yes

Minimum Temperature 50 °C

Maximum temperature 250 °C

Second Oven Technical Features



Net volume of the second cavity 55 l

Gross volume, 2nd cavity 70 l

Cavity material Ever Clean enamel

No. of shelves 4

Type of shelves Metal racks

No. of lights 1

Light type Halogen

Light Power 40 W

Cooking time setting Minute minder

Light when oven door is open Yes

Door opening Flap down

Removable door Yes

Full glass inner door Yes

No. total door glasses 3

No. thermo-reflective door glasses 2

Safety Thermostat Yes

Cooling system Tangential

Usable cavity space dimensions (HxWxD) 290x444x425 mm

Temperature control Electro-mechanical

Lower heating element - power 1100 W

Upper heating element - Power 1000 W

Grill element - power 1700 W

Large grill - Power 2700 W

Grill type Electric

Tilting grill Yes

Options Auxiliary Oven

Timer Yes

End of cooking acoustic alarm Yes

Minimum Temperature 50 °C

Maximum temperature 300 °C

Accessories included for Main Oven & Hob



Rack with back and side stop 1

20mm deep tray 1

40mm deep tray 1

Grill mesh 1

Catalytic panels 3

Telescopic Guide rails, total Extraction 1

Pizza Accessories Refractory stone + cover + shovel

Accessories included for Secondary Oven

Rack with back and side stop 1
 40mm deep tray 1

Grill mesh 1
 Catalitic panels 3

Electrical Connection

Electrical connection rating 7500 W
 Current 33 A
 Voltage 220-240 V
 Voltage 2 (V) 380-415 V

Type of electric cable installed Yes, Double and Three Phase
 Power supply cable length 150 cm
 Frequency 50/60 Hz
 Terminal block 5 poles

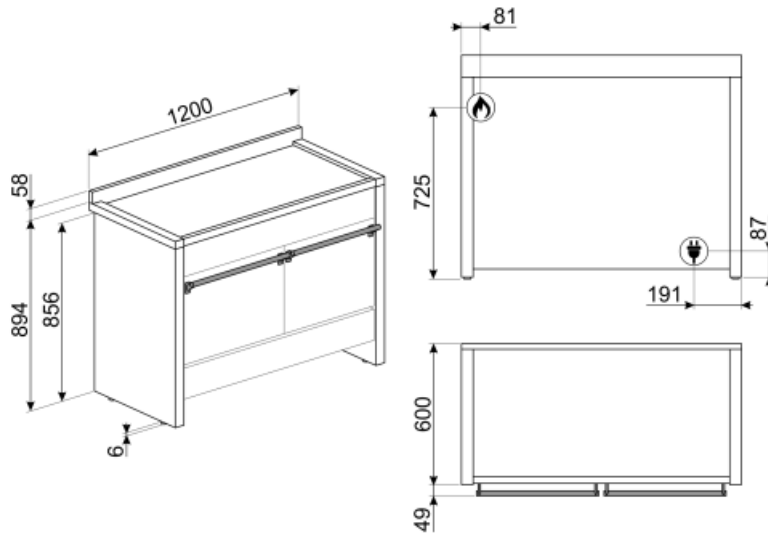

Not included accessories



KIT1A3-8

Splashback, stainless steel, 120cm, suitable for Opera A3 cookers



KIT2A3-2

Plinth, 120 cm, only frontal, stainless steel suitable for A3 and A4 Opera cookers



GTP

Partially extractable telescopic guides (1 level), suitable for traditional ovens. Made in stainless steel, they guarantee stability and facilitate the smooth extraction of the trays.



BNP608T

Teflon-coated tray, 8mm depth, to be placed on the grid



KIT3-6

Height extension kit 2 lateral sides (950mm), stainless steel, for Opera cookers A2, A3, A4 (945-965mm)



BN620-1

Enamelled tray suitable for 45cm and 60cm ovens. Depth 20 mm. Perfect for a wide range of savoury and sweet baking.



GT1P-2

Partially extractable telescopic guides (1 level) for ovens with metal frames. Length: 355.5 mm, extraction: 285 mm. Material: Stainless steel AISI 430 polished.



PALPZ

Pizza shovel with folding handle. Dimensions L31.5 x H32.5 cm. Easy and convenient to use and store. Perfect for serving pizza, bread and savory pastries in a safe and professional way.



AIRFRY

Air fryer rack AIRFRY. Ideal for recreating traditional frying in the oven, but with fewer calories and less fat. It allows you to cook quickly and simply dishes such as French fries, fried vegetables and fish, ensuring perfect browning and crispiness.



SFLK1

Child lock



PRTX

Refractory pizza stone with handles. D=35cm Not suitable for microwave ovens. Suitable for gas ovens, to be put on the griddle.



GRM

Coffee machine support



TPKX

Stainless steel Teppanyaki plate, suitable for A1-9 Opera cooker



GC120

Cast iron grill plate suitable for A3/A4/A5 cookers



BBQ

Double sided plate BBQ. Suitable for recreating succulent and crispy dishes in the oven with the typical taste of grilled cooking. The ribbed side is particularly suitable for meats and cheeses. The smooth side for fish, seafood and vegetables.



GTT

Totally extractable telescopic guides (1 level), suitable for traditional ovens. Made in stainless steel, they guarantee stability and facilitate the smooth extraction of the trays.



BN640



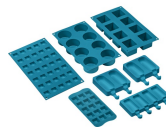









Enamelled tray suitable for 45cm and 60cm ovens. Depth 540 mm. Perfect for cooking and roasting meat and fish in sauces. Also ideal for experimenting with lighter and crunchy side dishes















SMOLD

Set of 7 silicone moulds for ice creams, ice lollies, pralines, ice cubes or to portion food. Usable from -60°C to +230°C

Symbols glossary (TT)

- A** A: Product drying performance, measured from A+++ to D / G depending on the product family
-  Air cooling system: to ensure a safe surface temperatures.
-  Ever Clean Enamel: Ever Clean enamel is applied electrostatically, corner to corner and edge to edge to prevent cracking or cracks over time. It is a particular pyrolytic enamel, resistant to acids which, in addition to being pleasantly bright, promotes greater cleaning of the oven walls, thanks to its lower porosity. It is baked at over 850 ° C and slowly polymerized at a scientifically determined rate to ensure uniform depth and strength Ever Clean enamel creates an impeccable finish both on the inside of the oven and on the trays, making the surfaces of the oven incredibly easy to maintain over time as it reduces the adhesion of fat during cooking
-  Fan assisted base: the mix of fan and lower heating element alone allows to finish cooking foods already cooked on the surface but not internally more quickly. This system is recommended to finish cooking foods that are already well cooked on the surface, but not internally, which therefore require a moderate higher heat. Ideal for any type of food.
-  Static: Traditional cooking suitable for the preparation of one dish at a time. The fan is not active and the heat comes from below and from above at the same time. Static cooking is slower and more delicate, ideal in order to get well cooked and dry dishes even inside. Ideal for cooking all types of roasts, fatty meats, bread, filled cakes.
-  ECO: low energy consumption cooking: this function is particularly suitable for cooking on a single shelf with low energy consumption. It is recommended for all types of food except those that can generate a lot of moisture (for example vegetables). To achieve maximum energy savings and reduce time, it is recommended to put the food in the oven without preheating the cooking compartment
-  Half grill: For rapid cooking and browning of foods. Best results can be obtained by using the top shelf for small items, the lower shelves for larger ones, such as chops or sausages. For half grill heat is generated only at the centre of the element, so is ideal for smaller quantities.
-  Heavy duty cast iron pan stands: for maximum stability and strength.
-  Triple glazed doors: Number of glazed doors.
-  Fingerprint proof stainless steel: Fingerprint proof stainless steel keeps stainless steel looking as good as new.
-  Fan assisted: Intense and homogeneous traditional cooking, also suitable for complex recipes. The fan is active and the heat comes from below and from above at the same time. Ventilated cooking ensures a faster and more homogeneous result, leaving fragrant foods outside and moister inside. Ideal for baked pasta, biscuits, roasts and cobblers.
-  Circulaire: it is the perfect function for cooking all types of dishes in a more delicate way. The heat comes from the back of the oven and is distributed quickly and evenly The fan is active. It is also ideal for cooking on multiple levels without mixing smells and flavors.
-  Grill: Very intense heat coming only from above from a double heating element. The fan is not active. Provides excellent grilling and gratinating results. Used at the end of cooking, it gives a uniform browning to dishes.
-  Fan grill: very intense heat coming only from above from a double heating element The fan is active. It allows the optimal grilling of thickest meats. Ideal for large cuts of meat.

-
- | | | | |
|--|--|---|---|
|  | Pizza function: Specific function for cooking pizza in a pan. It allows to obtain a pizza that is soft inside and crispy outside with the topping perfectly cooked, not dry and not burnt. |  | All glass inner door: All glass inner door, a single flat surface which is simple to keep clean. |
|  | Side lights: Two opposing side lights increase visibility inside the oven. |  | Overfill protection: The special overfill protection shuts down the stove in the presence of overflow of liquids. |
|  | The oven cavity has 4 different cooking levels. |  | Telescopic rails: allow you to pull out the dish and check it without having to remove it from the oven entirely. |
|  | Electronic control: Allows you to maintain temperature inside the oven with the precision 2-3 ° C. This enables to cook meals that are very sensitive to temperature changes, such as cakes, souffles, puddings. |  | Tilting grill: the tilting grill can be easily unhooked to move the heating element and clean the roof of the appliance in one simple step. |
|  | Ultra rapid burners: Powerful ultra rapid burners offer up to 5kw of power. |  | Vapor Clean: a simple cleaning function using steam to loosen deposits in the oven cavity. |
|  | The capacity indicates the amount of usable space in the oven cavity in litres. |  | The capacity indicates the amount of usable space in the oven cavity in litres. |