

# VSTR40DKX

Sink material	Stainless steel
Type	Monoblock bowl
No. of bowls	1
EAN code	8017709276805



## Aesthetics



Aesthetic	Universale	Building in type	Undermount
Serie	Mira	Logo	Embossed
Colour	Black	Tap hole / precut tap hole	No Taphole
Finishing	PVD Brushed		

	Bowl type	Bowl dimensions, WxDxH (mm)	Bowl depth (mm)	Radius corner bowl	Overflow	Strainer position	Strainer dimension
Bowl	Minimum radius	400 x 400 x 200	200	15	Yes, flush fitted	Wall position	3.5"

## Technical Features



Characteristics PVD coating	Coating thickness , Eco-friendly, Easy to clean, Hypoallergenic	Tap hole diameter	35 mm
Dimensions of the product (mm)	200x440x440 mm	No. of clips	8
Cutout dimension undermount (mm)	404*404 mm	Type of clips	Undermount clip
Base unit size	60 cm		

## Accessories Included

Accessories for  
installation

Strainer, Savespace siphon  
with dishwasher outlet  
connection, Fixing clips

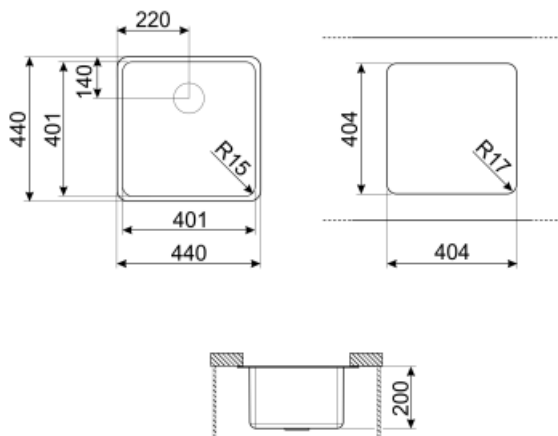

---

## Not included accessories

---



### KITFD050

Waste disposal 0,5 HP, Motor: 1/2 horsepower, Fits all sinks with 3 1/2" waste outlet



### KITFD100

Waste disposal 1 HP, Motor: 1/2 horsepower, Fits all sinks with 3 1/2" waste outlet



### DB34

St/steel drain basket to fit STD radius 340 x 400 bowl, 180 mm depth



### 3712

Siphon single bowl sinks (dishwasher connection included)



### 3713

Siphon double bowls sinks (dishwasher connection included)









### KITFD075

Waste disposal 0,75 HP, Motor: 1/2 horsepower, Fits all sinks with 3 1/2" waste outlet

## Symbols glossary (TT)

---

- |  |   |   |   |
|--|---|---|---|
|  | Cupboard width required for sink installation   |  | Sink depth - depending on the model, the depth can be from 13 to 24,5     |
|  | Under table top installation: The sink is fixed under tabletop, which extends the work surface and the depth of the sink. |  | Easy to clean   |
|  | Coating thickness between 0.2mm and 2mm   |  | PVD coatings are hypoallergenic and suitable for use in contact with food |
|  | The manufacturing process of PVD treatment is 100% green and eco-friendly   |   |   |