

# CPF120IGMPX

Cooker size	120x60 cm
N. of cavities with energy label	2
Cavity heat source	ELECTRICITY
Hob type	Mixed
Type of main oven	Thermo-ventilated
Type of second oven	Thermo-ventilated
Cleaning system main oven	Pyrolitic
EAN code	8017709278267
Energy efficiency class	A+
Energy efficiency class, second cavity	A



## Aesthetics











<b>Aesthetic</b>	Portofino	<b>Display</b>	Touch
<b>Colour</b>	Stainless steel	<b>No. of controls</b>	11
<b>Finishing</b>	Satin	<b>Serigraphy colour</b>	Black
<b>Design</b>	Flush fit	<b>Handle</b>	Smeg Portofino
<b>Door</b>	With frame	<b>Handle Colour</b>	Brushed stainless steel
<b>Upstand</b>	Yes	<b>Glass type</b>	Black
<b>Type of pan stands</b>	Cast Iron	<b>Plinth</b>	Black
<b>Hob colour</b>	Stainless steel	<b>Storage compartment</b>	Drawer
<b>Command panel finish</b>	Finger friendly stainless steel	<b>Sliding compartment</b>	Yes
<b>Control knobs</b>	Smeg Portofino	<b>Logo</b>	Assembled st/steel
<b>Controls colour</b>	Stainless steel	<b>Logo position</b>	Facia below the oven

## Programme / Functions

No. of cooking functions 9

Traditional cooking functions

 Static	 Fan assisted	 Circulaire
 Turbo	 Eco	 Small grill
 Large grill	 Fan grill (large)	 Fan assisted bottom

## Cleaning functions



Pyrolytic

## Programs / Functions Auxiliary Oven

Cooking functions cavity 2 8

Traditional cooking functions, cavity 2



Static



Fan assisted



Circulaire



Eco



Large grill



Fan grill (large)



Fan-assisted bottom

Cooking functions with Direct Steam technology



Fan forced (circular heating + fan)

Cleaning functions cavity 2

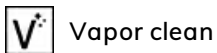

Vapor clean

## Hob technical features



Total no. of cook zones 6

Centrale sinistra - Gas - 2UR (dual) - 4.20 kW

Front centre - Gas - Semi Rapid - 1.80 kW

Rear centre - Gas - Rapid - 3.00 kW

Front right - Induction - multizone - 2.10 kW - Booster 2.30 kW - 21.1x19.1 cm

Rear right - Induction - multizone - 1.60 kW - Booster 1.85 kW - 21.0x19.0 cm

Central - Teppanyaki - 1.40 kW

Type of gas burners	Standard	Automatic pan detection	Yes
Automatic electronic ignition	Yes	Minimum pan diameter indication	Yes
Burner caps	Matt black enamelled	Selected zone indicator	Yes
Automatic switch off when overheat	Yes	Residual heat indicator	Yes

## Main Oven Technical Features



No. of lights 2

Fan number 1

Net volume of the cavity 70 l

Total no. of door glasses 4

<b>Gross volume, 1st cavity</b>	79 l	<b>No. of thermo-reflective door glasses</b>	3
<b>Cavity material</b>	Ever Clean enamel	<b>Safety Thermostat</b>	Yes
<b>No. of shelves</b>	5	<b>Heating suspended when door is opened</b>	Yes
<b>Type of shelves</b>	Metal racks	<b>Cooling system</b>	Tangential
<b>Light type</b>	Halogen	<b>Door Lock During Pyrolysis</b>	Yes
<b>Light Power</b>	40 W	<b>Usable cavity space dimensions (HxWxD)</b>	360X460X425 mm
<b>Cooking time setting</b>	Start and Stop	<b>Temperature control</b>	Electro-mechanical
<b>Light when oven door is open</b>	Yes	<b>Lower heating element power</b>	1200 W
<b>Door opening</b>	Flap down	<b>Upper heating element - Power</b>	1000 W
<b>Removable door</b>	Yes	<b>Grill element</b>	1700 W
<b>Full glass inner door</b>	Yes	<b>Large grill - Power</b>	2700 W
<b>Removable inner door</b>	Yes	<b>Circular heating element - Power</b>	2000 W
		<b>Grill type</b>	Electric
		<b>Soft Close system</b>	Yes

## Options Main Oven

<b>Timer</b>	Yes	<b>Minimum Temperature</b>	50 °C
<b>End of cooking acoustic alarm</b>	Yes	<b>Maximum temperature</b>	280 °C

## Second Oven Technical Features



<b>Net volume of the second cavity</b>	63 l	<b>No. thermo-reflective door glasses</b>	2
<b>Gross volume, 2nd cavity</b>	79 l	<b>Safety Thermostat</b>	Yes
<b>Cavity material</b>	Ever Clean enamel	<b>Heating suspended when door is opened</b>	Yes
<b>No. of shelves</b>	5	<b>Cooling system</b>	Tangential
<b>Type of shelves</b>	Metal racks	<b>Usable cavity space dimensions (HxWxD)</b>	360X460X425 mm
<b>No. of lights</b>	2	<b>Temperature control</b>	Electro-mechanical
<b>Light type</b>	Halogen	<b>Lower heating element - power</b>	1200 W
<b>Light Power</b>	40 W	<b>Upper heating element - Power</b>	1000 W
<b>Cooking time setting</b>	Start and Stop	<b>Grill element - power</b>	1700 W
<b>Light when oven door is open</b>	Yes	<b>Large grill - Power</b>	2700 W
<b>Door opening</b>	Flap down	<b>Circular heating element - Power</b>	2000 W
<b>Removable door</b>	Yes	<b>Grill type</b>	Electric
<b>Full glass inner door</b>	Yes	<b>Tilting grill</b>	Yes
<b>Removable inner door</b>	Yes		
<b>No. total door glasses</b>	3		

Soft Close system Yes

## Options Auxiliary Oven

Timer	Yes	Minimum Temperature	50 °C
End of cooking acoustic alarm	Yes	Maximum temperature	260 °C

## Accessories included for Main Oven & Hob



Rack with back and side stop	1	Grill mesh	1
20mm deep tray	1	Telescopic Guide rails, total Extraction	1
40mm deep tray	1	Meat Probe	1

## Accessories included for Secondary Oven



Rack with back and side stop	1	Grill mesh	1
20mm deep tray	1	Telescopic Guide rails, total Extraction	1
40mm deep tray	1		

## Electrical Connection

Electrical connection rating	10900 W	Cable testing	Yes, Single phase
Current	32 A	Additional connection modalities	Yes, Double and Three Phase
Voltage	220-240 V	Frequency	50/60 Hz
Voltage 2 (V)	380-415 V	Terminal block	5 poles
Type of electric cable installed	Yes, Single phase		

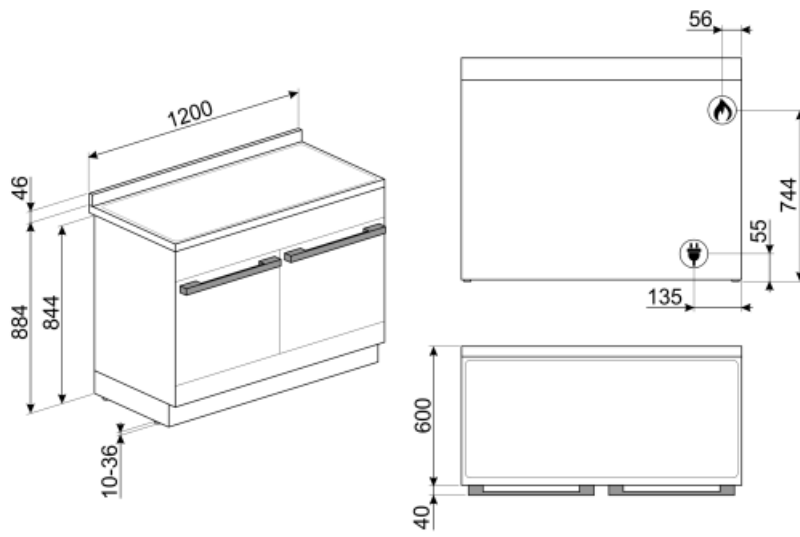

## Not included accessories

### AIRFRY

Air fryer rack AIRFRY . Ideal for recreating traditional frying in the oven, but with fewer calories and less fat. It allows you to cook quickly and simply dishes such as French fries, fried vegetables and fish, ensuring perfect browning and crispiness.



### GTP

Partially extractable telescopic guides (1 level), suitable for traditional ovens. Made in stainless steel, they guarantee stability and facilitate the smooth extraction of the trays.



### BNP608T

Teflon-coated tray, 8mm depth, to be placed on the grid



### GRILLPLATE

Universal griddle for induction, gas, ceramic and electric hobs. Non-stick surface ideal for cooking meat, cheese and vegetables. Dimensions: 410 x 240 mm.



### BN620-1

Enamelled tray suitable for 45cm and 60cm ovens. Depth 20 mm. Perfect for a wide range of savoury and sweet baking.



### SCRP

Non-scratch hob scraper - suitable for induction and ceramic hobs



### KITH95CPF120

Height extension kit (950 mm), suitable for 120cm Portofino cookers (940-960mm)



### SFLK1

Child lock



### PRTX

Refractory pizza stone with handles. D=35cm Not suitable for microwave ovens. Suitable for gas ovens, to be put on the griddle.



### KITP65CPF120

Depth extension kit (650mm), black, suitable for 120cm Portofino cookers



### WOKGHU

Cast iron WOK Support



### KIT1CPF120X

Splashback, 120cm, stainless steel, suitable for Portofino cookers



### BGTR4110

Cast iron grill plate suitable for Victoria Cookers TR4110



### BBQ

Double sided plate BBQ. Suitable for recreating succulent and crispy dishes in the oven with the typical taste of grilled cooking. The ribbed side is particularly suitable for meats and cheeses. The smooth side for fish, seafood and vegetables.





#### TPKPLATE

Universal plate for induction, gas, ceramic and electric hobs. Non-stick surface ideal for cooking fish, eggs and vegetables. Dimensions: 410 X 240 mm.



#### GTT

Totally extractable telescopic guides (1 level), suitable for traditional ovens. Made in stainless steel, they guarantee stability and facilitate the smooth extraction of the trays.

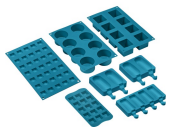

#### SMOLD

Set of 7 silicone moulds for ice creams, ice lollies, pralines, ice cubes or to portion food. Usable from -60°C to +230°C



#### PALPZ

Pizza shovel with folding handle. Dimensions L31.5 x H32.5 cm. Easy and convenient to use and store. Perfect for serving pizza, bread and savory pastries in a safe and professional way.



#### BN640

Enamelled tray suitable for 45cm and 60cm ovens. Depth 540 mm. Perfect for cooking and roasting meat and fish in sauces. Also ideal for experimenting with lighter and crunchy side dishes

## Alternative products

---



CPF120IGMPWH



CPF120IGMPR















CPF120IGMPBL





















CPF120IGMPT



## Symbols glossary (TT)

- A** A: Product drying performance, measured from A+++ to D / G depending on the product family
- A+** A+: Energy efficiency class A+ helps to save up to 10% energy compared to class A. Maximum performance with minimum consumption is guaranteed.
-  Heavy duty cast iron pan stands: for maximum stability and strength.
-  A DIRECT STEAM oven has 1 steam cooking function to which the user can MANUALLY add steam. The function is activated when the user turns the function
-  Air cooling system: to ensure a safe surface temperatures.
-  Triple glazed doors: Number of glazed doors.
-  Quadruple glazed: Number of glazed doors.
-  ECO-logic: option allows you to restrict the power limit of the appliance real energy saving.
-  Ever Clean Enamel: Ever Clean enamel is applied electrostatically, corner to corner and edge to edge to prevent cracking or cracks over time. It is a particular pyrolytic enamel, resistant to acids which, in addition to being pleasantly bright, promotes greater cleaning of the oven walls, thanks to its lower porosity. It is baked at over 850 ° C and slowly polymerized at a scientifically determined rate to ensure uniform depth and strength Ever Clean enamel creates an impeccable finish both on the inside of the oven and on the trays, making the surfaces of the oven incredibly easy to maintain over time as it reduces the adhesion of fat during cooking
-  Fingerprint proof stainless steel: Fingerprint proof stainless steel keeps stainless steel looking as good as new.
-  Fan assisted base: the mix of fan and lower heating element alone allows to finish cooking foods already cooked on the surface but not internally more quickly. This system is recommended to finish cooking foods that are already well cooked on the surface, but not internally, which therefore require a moderate higher heat. Ideal for any type of food.
-  Fan assisted: Intense and homogeneous traditional cooking, also suitable for complex recipes. The fan is active and the heat comes from below and from above at the same time. Ventilated cooking ensures a faster and more homogeneous result, leaving fragrant foods outside and moister inside. Ideal for baked pasta, biscuits, roasts and cobblers.
-  Static: Traditional cooking suitable for the preparation of one dish at a time. The fan is not active and the heat comes from below and from above at the same time. Static cooking is slower and more delicate, ideal in order to get well cooked and dry dishes even inside. Ideal for cooking all types of roasts, fatty meats, bread, filled cakes.
-  Circulaire: it is the perfect function for cooking all types of dishes in a more delicate way. The heat comes from the back of the oven and is distributed quickly and evenly The fan is active. It is also ideal for cooking on multiple levels without mixing smells and flavors.

- |   |  |
|---|--|
|  <p><b>ECO:</b> low energy consumption cooking: this function is particularly suitable for cooking on a single shelf with low energy consumption. It is recommended for all types of food except those that can generate a lot of moisture (for example vegetables). To achieve maximum energy savings and reduce time, it is recommended to put the food in the oven without preheating the cooking compartment</p>                          |  <p><b>Grill:</b> Very intense heat coming only from above from a double heating element. The fan is not active. Provides excellent grilling and gratinating results. Used at the end of cooking, it gives a uniform browning to dishes.</p>  |
|  <p><b>Half grill:</b> For rapid cooking and browning of foods. Best results can be obtained by using the top shelf for small items, the lower shelves for larger ones, such as chops or sausages. For half grill heat is generated only at the centre of the element, so is ideal for smaller quantities.</p>  |  <p><b>Fan grill:</b> very intense heat coming only from above from a double heating element The fan is active. It allows the optimal grilling of thickest meats. Ideal for large cuts of meat.</p>   |
|  <p><b>Turbo:</b> the heat comes from 3 directions: above, below and from the back of the oven The fan is active. It allows quick cooking, even on several shelves without mixing the aromas. Ideal for large volumes or foods that require intense cooking.</p>  |  <p><b>Circulaire pulsed steam:</b> Provides extra moisture to food during cooking. Excellent for bread baking. The moisture allows the bread dough to stretch further at the beginning of cooking, creating an aerated and light textured dough. The remaining part of the cooking process allows for the signature crust to form.</p> |
|  <p><b>Overheat protection:</b> The safety system that automatically turns off the hob in case of overheating of the control unit.</p>  |  <p><b>All glass inner door:</b> All glass inner door, a single flat surface which is simple to keep clean.</p>   |
|  <p><b>The inner door glass:</b> can be removed with a few quick movements for cleaning.</p>  |  <p><b>Side lights:</b> Two opposing side lights increase visibility inside the oven.</p>   |
|  <p><b>PYROLYSIS - AUTOMATIC CLEANING FUNCTION:</b> the oven heats up to a temperature approaching 500 ° C and chars grease and food residues into a fine ash that can be easily wiped off with a damp cloth. At such a high temperature, the door locks automatically for safety, while the temperature of the door remains controlled so it is safe to touch User adjustable function based on the level of dirt present in the oven.</p> |  <p><b>Indication of residual heat:</b> After the glass ceramic hob is switched off the residual heat indicator shows which of the heating zones still remains hot. When the temperature drops below 60 ° C, the indicator goes out.</p>  |
|  <p><b>The oven cavity has 5 different cooking levels.</b></p>  |  <p><b>Soft close:</b> all models are equipped with advanced function of smooth closing of the door, which allows the device to close smoothly and quietly.</p>   |
|  <p><b>Telescopic rails:</b> allow you to pull out the dish and check it without having to remove it from the oven entirely.</p>  |  <p><b>Electronic control:</b> Allows you to maintain temperature inside the oven with the precision 2-3 ° C. This enables to cook meals that are very sensitive to temperature changes, such as cakes, souffles, puddings.</p>   |
|  <p><b>Tilting grill:</b> the tilting grill can be easily unhooked to move the heating element and clean the roof of the appliance in one simple step.</p>  |  <p><b>Ultra rapid burners:</b> Powerful ultra rapid burners offer up to 5kw of power.</p>  |



Vapor Clean: a simple cleaning function using steam to loosen deposits in the oven cavity.



The capacity indicates the amount of usable space in the oven cavity in litres.



The capacity indicates the amount of usable space in the oven cavity in litres.