

# LZ102AV2

|               |                |
|---------------|----------------|
| Sink material | Composite      |
| Type          | Composite sink |
| No. of bowls  | 1 + 1/2        |
| Drainer       | Reversible     |
| EAN code      | 8017709274566  |



## Aesthetics



|                         |            |                                      |  |
|-------------------------|------------|--------------------------------------|--|
| <b>Aesthetic</b>        | Universale | <b>Logo</b>                          | Applied/on overflow                                  |
| <b>Serie</b>            | Rigae      | <b>Alternative colours available</b> | White, Anthracite, Cream, Copper, Cemento / Concrete |
| <b>Colour</b>           | Oats       | <b>Tap hole / precut tap hole</b>    | Prepared   |
| <b>Building in type</b> | Standard   |                                      |  |

|         | Bowl type RH | Bowl dimensions, WxDxH (mm) | Bowl depth (mm) | Radius corner right bowl (mm) | Overflow LH bowl | Strainer position | Strainer dimension |
|---------|--------------|-----------------------------|-----------------|-------------------------------|------------------|-------------------|--------------------|
| RH Bowl | Half bowl    | 150 x 340 x 168             | 168             | 50                            |                  | Centre of bowl    | 3.5"               |
| LH Bowl | Traditional  | 420 x 320 x 210             | 210             | 80                            | Yes, traditional | Side bowl         | 3.5"               |

## Technical Features



|   |  |                            |          |
|---|--|----------------------------|----------|
| <b>Characteristics composite material</b> | Antibacterial, Anti-scratch, Termal schock resistant, High temperatures resistant, Impact resistant, Easy to clean, UV Resistant | <b>Tap hole</b>            | 2        |
| <b>Frame depth (mm)</b>                   | 10   | <b>Tap hole diameter</b>   | 35 mm    |
| <b>Dimensions of the product (mm)</b>     | 210x1000x500 mm  | <b>Dividing wall width</b> | 38 mm    |
|   |  | <b>Drainer inclination</b> | 2 °      |
|   |  | <b>No. of clips</b>        | 10       |
|   |  | <b>Type of clips</b>       | Standard |

---

|                                |              |
|--------------------------------|--------------|
| Cutout dimension topmount (mm) | 980 X 480 mm |
| Undermount cutout radius       | 30 mm        |
| Height from kitchen top        | 10 mm        |
| Base unit size                 | 60 cm        |

## Accessories Included

---

|                              |  |
|------------------------------|--|
| Accessories for installation | Strainer, Savespace siphon with dishwasher outlet connection, Fixing clips |
|------------------------------|--|

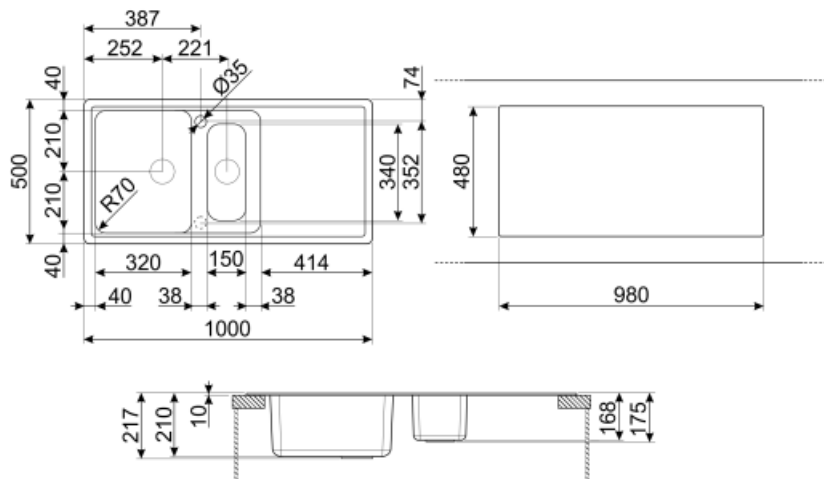

## Not included accessories

---



### **KITFD050**

Waste disposal 0,5 HP, Motor: 1/2 horsepower, Fits all sinks with 3 1/2" waste outlet



### **KITFD100**

Waste disposal 1 HP, Motor: 1/2 horsepower, Fits all sinks with 3 1/2" waste outlet



### **KITDSQ**

Soap dispenser chrome finishing with square knob 40x40 mm















### **KITFD075**

Waste disposal 0,75 HP, Motor: 1/2 horsepower, Fits all sinks with 3 1/2" waste outlet

---

## Symbols glossary (TT)

---

|  |   |   |  |
|--|---|---|--|
|  | Cupboard width required for sink installation   |  | Sink depth - depending on the model, the depth can be from 13 to 24,5                      |
|  | Sink depth - depending on the model, the depth can be from 13 to 24,5   |  | Standard installation: Traditional installation in tabletop, suitable for any kitchen sets |
|  | Antibacterial   |  | Antiscratch  |
|  | Thermal shock resistant   |  | High temperatures resistant  |
|  | Impact resistant  |  | Easy to clean  |
|  | Thanks to the double tap hole, most of our sinks are easily reversible, giving you the flexibility to make any type of kitchen composition. |  | UV protection, does not fade over time.  |