

MID5CR



Product family	Taps
Material	Brass
Swivelling spout	Yes
Swivelling spout rotation	180 °



Aesthetics



Aesthetic	Universale	Handshower	Mobile semi-professional
Colour	Chrome	Jet type	Double jets
Finishing	Glossy	Aerator	Yes
Spout type	Spring spout	Flexible hoses number	2
Tap type	Semi-professional single lever		

Technical Features

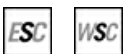

Characteristics	ESC, WSC	Minimum pressure	1 bar
Flexible hoses lenght	500 mm	Optimal pressure	3 bar
Flexible hoses connection	3/8 "	Water production (l/min)	12 l
Ceramic disc cartridge type	35 Ø	Tap hole diameter	35 mm
Maximum pressure	5 bar		

Logistic Information

Product height (mm)	550 mm
---------------------	--------

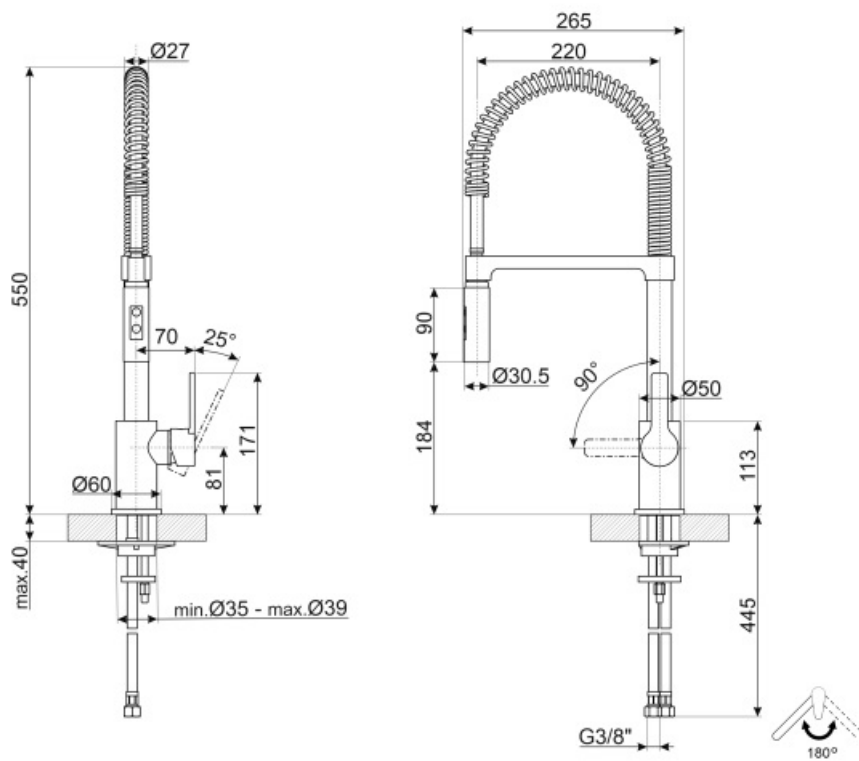





Not included accessories



STABMIX
Tap stabiliser

Symbols glossary (TT)

- | | |
|--|---|
|  <p>ESC: with the ESC Energy Saving Cartridge system the control lever positioned in the middle dispenses only cold water, and not 50% of hot and 50% of c</p> |  <p>WSC: with the WSC Water Saving Cartridge the control lever stops halfway, causing 50% of the water (sufficient for normal cooking activities) to be di</p> |
|  <p>Swivel spout rotation 180°</p> |  <p>Double jet handshower. It is possible to simply switch between a standard stream mode and a spray mode.</p> |
|  <p>The mobile hand shower of the Semi-Professional taps with high spout allows you to easily reach every point of the sink.</p> | |